

**EXPERIMENTAL STUDY ON THE PERFORMANCE OF MECHANICAL INDUCED
DRAFT COOLING TOWER USING DIFFERENT QUANTITY OF CIRCULATING
FLUIDS**

A thesis submitted to the Department of Mechanical Engineering, Military Institute of Science and technology, Dhaka, in December, 2017 in partial fulfillment of the requirements for the degree of Bachelor of Science in Mechanical Engineering.

SUBMITTED BY

Maj. Sayem Adnan Bin Rahman

Student No. 201418001

Md. Monjur Rahman

Student No. 201418051

Alimul Khadem

Student No. 201418082

MILITARY INSTITUTE OF SCIENCE AND TECHNOLOGY (MIST)



SUPERVISED BY

Brig Gen Md Habibur Rahman

Senior Instructor and Head of the Department, ME Department

Military Institute of Science & Technology

STUDENT DECLARATION

This is to certify that the thesis entitled, “**EXPERIMENTAL STUDY ON THE PERFORMANCE OF MECHANICAL INDUCED DRAFT COOLING TOWER USING DIFFERENT QUANTITY OF CIRCULATING FLUIDS**” is an outcome of the investigation carried out by the author under the supervision of, **Brig Gen Md Habibur Rahman, Senior Instructor and Head of the Department, Mechanical Engineering Department, MIST**. This thesis or any part of it has not been submitted to elsewhere for the award of any other degree or diploma or other similar title or prize.

SUBMITTED BY

Maj. Sayem Adnan Bin Rahman
Student no: 201418001

Md. Monjur Rahman
Student no: 201418051

Alimul Khadem
Student no: 201418082

SUPERVISOR CERTIFICATION

This is to certify that Maj. Sayem Adnan Bin Rahman, Student no: 201418001; Md. Monjur Rahman, Student no: 201418051; Alimul Khadem, Student no: 201418082 have completed their undergraduate thesis report on **“EXPERIMENTAL STUDY ON THE PERFORMANCE OF MECHANICAL INDUCED DRAFT COOLING TOWER USING DIFFERENT QUANTITY OF CIRCULATING FLUIDS”** under my supervision. To the best of my knowledge, the report is their original work and was not submitted elsewhere for other purpose.

I wish their ever success in life.

APPROVED BY

Brig Gen Md Habibur Rahman,
Senior Instructor and Head of the Department, Mechanical Engineering Department,
Military Institute of Science & Technology (MIST)
Mirpur Cantonment, Dhaka.

ACKNOWLEDGEMENT

First of all, we are grateful to Allah, the almighty for giving us the courage and enthusiasm to complete the thesis work.

The authors express their profound gratitude to **Brig Gen Md Habibur Rahman, Senior Instructor and Head of the ME Department.**

The authors are very grateful to **Maj. Md. Altab Hossain**, PhD, Department of Nuclear Science & Engineering, MIST and to **Engg. Shahed Hossian**, Managing director of Artisan craft BD. They have helped us to establish the experimental set up of the cooling tower and inspired us a lot.

We are also grateful to all of the staffs and lab assistants of machine tools lab, heat transfer lab and thermodynamics lab of MIST with measurement devices for completing our experiment.

Finally we would like to thank everybody who supported us in any respect for the completion of the thesis.

The Authors

Department of Mechanical Engineering
Military Institute of Science and Technology
Mirpur Cantonment, Dhaka-1216
December, 2017

ABSTRACT

Cooling towers are evaporative heat transfer devices in which atmospheric air cools warm water with direct contact between the air and the water by evaporating cooling of water. The main objective of this study is to analysis the cooling tower performance, comparing the performance of natural and induced draft cooling tower and finding out the effect of adding toner to circulating cooling fluids. This was done by establishing and modifying experimental set up constructing computer program and varying the quality of circulating fluids by adding together at different ratio. Natural and induced draft cooling tower and computer program gives us the various data required for calculation. From the result obtained a comparative study on terms of tower characteristics (kav/L), water to air flow ratio (L/G), efficiency, range, percentage of make-up water and evaporation heat loss are presented in graphical form. The graph showed that the performance of cooling tower is affected by the type of cooling tower and the quality of circulating fluids. The graphical analysis shows the cooling tower characteristics and efficiency decrease with an increase in (L/G) the induced draft cooling tower shows better performance than natural draft cooling tower. The result also shows that with the adding of toner with water cooling tower performance increase and as tower percentage increases the tower performance also increase.

Contents

Chapter One - INTRODUCTION	14
1.1 Introduction.....	15
1.2 Objectives of Thesis	16
1.3 Historical Background.....	16
1.4 Motivation.....	19
1.5 Thesis Organization	19
Chapter Two - LITERATURE REVIEW	20
2.1 Basic Concept	20
2.2 First Law of Thermodynamics	21
2.3 Second Law of Thermodynamics	23
2.4 Modes of Heat Transfer.....	25
2.4.1 Heat Transfer by Conduction:.....	25
2.4.2 Heat Transfer by Convection.....	26
2.4.3 Heat Transfer by Radiation	27
2.5 Cooling Tower	27
2.5.1Types of Cooling Tower.....	28
2.5.1.1 On the basis of Heat Transfer Mode	29
2.5.1.2 On the Basis of Shape	29
2.5.1.3 On the Basis of Construction	30
2.5.1.4 On the Basis of Air Flow	30
2.5.1.5 On the basis of Air Draft.....	31
2.5.1.6 On the basis of type of fill.....	32

Chapter Three - METHODOLOGY.....	34
3.1 Mathematical Modeling.....	35
3.2 Parameters.....	41
3.4 Component.....	42
3.4.1 Cooling Tower	42
3.4.2 Pump	45
3.4.3 Reservoir	46
3.4.4 Flow Meter.....	46
3.4.5 Thermocouple.....	47
3.4.6 Humidity Sensor.....	48
3.4.7 Anemometer	48
3.4.8 Thermocouple Controller.....	49
3.4.9 Arduino	50
3.4.10 Black Soot(Ink)	50
Chapter Four - Experimental Set Up and Procedure.....	52
4.1 Developed Experimental Setup.....	53
4.2 Schematic Diagram.....	54
4.3 Water Circuit	55
4.4 Air Circuit.....	58
4.5 Water Properties Measurement	59
4.6 Air properties measurement	60
4.7 Data Collection & Calculation.....	61
Chapter Five - Result & Discussion	67

5.1 Cooling Tower Characteristics Analysis.....	68
5.2 Comparative Study of Performance of Induced & Natural Draft Cooling Tower.....	74
5.3 Effect of Ambient Humidity on Cooling Tower Performance.....	79
5.4 Comparison of Cooling Tower Performance with Cooling Fluid of Various Quality	82
Chapter Six - Conclusion	92
6.1 Conclusion	93
6.2 Limitations.....	93
6.3 Recommendation.....	94
References	95
Appendix: A.....	96
Appendix B	116
Appendix C	123

List of figures

Figure 2.1: Configuration of cross flow and counter flow cooling tower	30
Figure 2.2: Configuration of forced draft and induced draft fans	32
Figure 2.3: A splash fill configuration	33
Figure 2.4: A film fill configuration	33
Figure 3.1: Cooling Tower Process Heat Balance	36
Figure 3.2: Bottled induced draft cooling tower	43
Figure 3.3: Centrifugal pump	45
Figure 3.4: Plastic variable area flow meter	46
Figure 3.5: Thermocouple Sensor	47
Figure 3.6; Humidity sensor	48
Figure 3.7: Anemometer	49
Figure 3.8: Thermocouple Controller	49
Figure 3.9: Arduino Circuit	50
Figure 3.10: Black Soot(Ink)	51
Figure 4.1: Developed Experimental Setup	53
Figure 4.2: Schematic Diagram of Induced Draft Counter Flow Cooling Tower	54
Figure 4.3: Water Circuit	55
Figure 4.4: Air Circuit	58
Figure 4.5: Water Properties Measurement Chart	59
Figure 4.6: Air Properties Measurement Chart	60
Figure 5.1: Efficiency vs NTU	68
Figure 5.2: Efficiency vs L/G	69
Figure 5.3: logNTU vs logL/G	70
Figure 5.4: Efficiency vs Flow Rate at Constant Inlet Temp.	71

Figure 5.5: Efficiency vs Flow Rate at different Inlet Temp.	72
Figure 5.6: Range vs Flow Rate	73
Figure 5.7: Evaporation Loss vs Water Inlet for Natural & Induced Draft Cooling Tower (At Constant Flow Rate)	74
Figure 5.8: Efficiency vs Approach (At same Flow Rate)	75
Figure 5.9: Efficiency vs Flow Rate (At same inlet temp.)	76
Figure 5.10: Water outlet Temp. vs Entering Wet Bulb Temperature of Air	77
Figure 5.11: Range vs Water Inlet at same Flow Rate	78
Figure 5.12: Dry Bulb Temperature vs Month	79
Figure 5.13: Avg. Ambient Relative Humidity vs Month	80
Figure 5.14: Efficiency vs Relative Humidity	81
Figure 5.15: Range vs Flow Rate of Induced Draft	82
Figure 5.16: Range vs Flow Rate of Natural Draft	83
Figure 5.17: Efficiency vs Flow Rate of Induced Draft	84
Figure 5.18: Efficiency vs Flow Rate of Natural Draft	85
Figure 5.19: Evaporation Loss vs Flow Rate of Induced Draft	86
Figure 5.20: Efficiency vs Ration of ink water	87
Figure 5.21: Range vs Ratio	88

List of Tables

Table 4.1: Induced Draft Cooling Tower	62
Table 4.2: Natural Draft Cooling Tower	62
Table 4.3: Induced Draft Cooling Tower with Ink (300ml/110L).....	63
Table 4.4: Natural Draft Cooling Tower with Ink (300ml/110L).....	63
Table 4.5: Induced Draft Cooling Tower with Ink (250ml/110L).....	64
Table 4.6: Natural Draft Cooling Tower with Ink (200ml/110L).....	64
Table 4.7: Induced Draft Cooling Tower with Ink (200ml/110L)	65
Table 4.8: Natural Draft Cooling Tower with Ink (200ml/110L).....	65
Table 4.9: Induced Draft Cooling Tower with Ink (150ml/110L).....	66
Table 4.10: Natural Draft Cooling Tower with Ink (150ml/110L).....	66

Nomenclature:

Symbol	Meaning
T_1	Dry Bulb Temperature of Inlet Air
T_2	Wet Bulb Temperature of Inlet Air
T_3	Dry Bulb Temperature of outlet Air
T_4	Wet Bulb Temperature of outlet Air
RH_i	Relative Humidity of Inlet Air
SH_i	Specific Humidity of Inlet Air
RH_o	Relative Humidity of Outlet Air
SH_o	Specific Humidity of Outlet Air
h_1	Enthalpy of Inlet Air
h_2	Enthalpy of outlet Air
TW_i	Water Inlet Temperature
TW_o	Water Outlet Temperature
\dot{m}_w	Flow Rate
R_{th}	Cooling Range
R_a	Cooling Approach
η	Cooling Efficiency
Δw	Change in Specific Humidity
\dot{m}_a	Mass Flow Rate of Air
M_w	Make up Water
Q_1	Change in Heat Content Water

Q_2	Change in Heat Content Air
Q_3	Evaporation loss
l_f	Latent Heat of Evaporation of Water
K	Mass transfer coefficient
A	Contact area per unit volume
V	Active cooling volume
L	Water flow rate
h'	Enthalpy of saturated air at temperature
h	Enthalpy of air steam
G	Air flow rate

Chapter One

INTRODUCTION

1.1 Introduction

Cooling tower is one of the most important utility device used in industries. In most cases it is used to provide cooling water to condenser. In the condenser cooling water takes up heat from the process steam or water and dissipate it to the atmosphere through cooling tower. In cooling tower, the cooling hot water enter and through evaporative and sensible heat exchange with air takes place. Thus heat is released to atmosphere with the air. We see cooling tower commonly used in thermal power plant to provide cooling water to condenser. In manufacturing industries for process cooling. In heating-ventilation and air conditioning (HVAC) cooling tower operation based on sensible cooling and evaporative cooling. In sensible cooling hot water is cooled to a lower temperature without phase change of water. But in evaporative cooling few of water content is evaporated during the process by absorbing heat from rest of the water. It is found that most of the heat transfer takes place in cooling tower are due to this evaporation. Through evaporative process 70 percent of heat is dissipated to atmosphere. On the basis of heat load conditions various types of cooling tower is designed and manufactured. Each types of cooling tower have different size and dimensions for different application. Cooling towers can be classified on the basis of air flow, shape, construction, fill and heat transfer. [11]

In this thesis project we try to study performance of two types of cooling tower. One of them is counter flow natural draft cooling tower and another one is induced draft cooling tower. Natural draft cooling tower is the one which uses the atmospheric air flow and in case of induced draft air induced inside the cooling tower with the use of an induced fan. Firstly natural draft and induced draft cooling tower are studied and their performance are compared. Effectiveness of cooling tower at different operating condition (flow rate, water inlet temperature etc) are calculated to identify the optimum condition. For water inlet outlet temperature reading thermocouple were used to obtain digital on a electronic display. For different air data Arduino circuit were used. Dry bulb temperature and humidity sensor is used to get a computerized data. From the data obtain in the computer other data were calculated with the use of psychometric chart. Using the first law of thermodynamic effectiveness of cooling tower is obtained. Then we repeat the whole process once again and measure all the parameters including humidity, enthalpy, dry bulb temperature, wet bulb temperature and others using working fluid which is a mixture of ink and water. After that we

compare this data with the data obtain by using natural water earlier. Then effectiveness at different condition is compared through graphical and analysis. Finally, limitation of the thesis project is highlighted and few recommendation is being made

1.2 Objectives of Thesis

- To Modify the Experimental Setup and Data Collection Procedure
- To Analysis the Performance of Cooling Tower and to compare in case of Induced Draft & Natural Draft Cooling Tower
- To analysis the performance of cooling tower with the addition of toner in water.
- To compare the performance of cooling tower with different ratio of toner and water mixture.

1.3 Historical Background

Modern water cooling towers were invented during the industrial age to disintegrate waste heat from industrial processes when natural cooling water sources were unavailable. By the early 20th century, advances in cooling towers were fueled by the rapidly growing electric power industry. The cooling loads created by the generation of electric power led to the development of large, custom-built structures typically constructed of wood. Cooling tower development continued to be based on the needs of these power-and-process users until the emergence of the commercial air conditioning market, which led the development of the modular, independently certified cooling towers of today. The development of the commercial air conditioning industry defined new criteria for cooling tower development. Contrary to process cooling towers, equipment intended for air conditioning applications had to be compact enough to fit in the restricted spaces available on commercial buildings. Cooling towers also had to meet the construction schedules of the rapidly growing demand for air conditioned buildings that characterized post-World War II America. With most air conditioning installations located in heavily populated urban areas, sound became a very important application consideration, and many municipal building or fire codes discouraged the use of combustible materials, including wood, in cooling tower construction. The above criteria could not be easily met by many cooling tower designs of the day that traced their origins to industrial applications.

By the late 1950s, factory-assembled cooling towers, incorporating quiet centrifugal fans and constructed of galvanized steel, were developed for commercial air conditioning projects. Innovations during the 1960s combined the cold water basin and fan sections of these factory-assembled, forced-draft cooling towers into one piece. This design innovation reduced space requirements and operating weights, facilitated cleaning of the cold water basin, provided protection for mechanical components, and simplified access to the fan-drive system. By the 1970s, the application of these cooling towers on commercial air conditioning systems accounted for approximately half of the hvac cooling tower installations.

The energy crisis of the mid-1970s placed increased awareness on energy efficiency in all aspects of American life, including commercial air conditioning systems. The operating characteristics of the centrifugal fan cooling tower began giving way to the energy reduction offered by the propeller fan units of industrial-style crossflow cooling towers. In the ensuing years, design strategies focused on incorporating the hvac cooling tower characteristics into the propeller fan, industrial crossflow cooling tower.

As development progressed into the 1980s and 90s, designs continued to concentrate on increasing thermal efficiency, simplifying maintenance, and reducing installation costs. The development of new, high-efficiency film fills, produced from lightweight, flame-retardant PVC, reduced the size and weight of crossflow cooling towers. Propeller fans, originally selected solely on air-handling considerations, incorporated sound characteristics as important selection criteria. New, belt-driven fan-drive systems were developed to provide reliable unit operation and reduce maintenance costs associated with the gear-driven systems of industrial-style units. Internal piping systems that reduced field piping requirements and allowed service personnel to perform routine maintenance of the water distribution system without mounting the fan deck were developed for crossflow cooling towers. Today, factory-assembled, crossflow cooling towers are considered to be the preferred configuration for air conditioning applications for their dependable, year-round operating reliability, accessible maintenance features, and low installation costs.

A significant milestone of the 1980s was the resurgence of a certification standard for the independent verification of cooling tower thermal performance. It had long been recognized that the thermal processes involved with cooling tower performance were not well understood, making the accurate prediction of thermal capabilities very difficult. Consequently, thermal ratings

published by cooling tower manufacturers were only as reliable as the manufacturers' best available technology. In 1981, the Cooling Tower Institute (currently the Cooling Technology Institute or CTI) updated and revised its certification standard STD-201. STD-201 established a procedure for manufacturers to voluntarily obtain independent verification that a line of cooling towers performs in accordance with the manufacturers' published thermal performance ratings. CTI certification ensures that owners and operators receive full value for their investment because the cooling tower performs at full-rated capacity. Furthermore, it eliminates the potential for years of excessive operating costs due to deficient equipment, and can actually reduce first cost by eliminating the need to oversize equipment or to perform a field acceptance test to verify performance.

In 1996, STD-201 was expanded to include closed-circuit, as well as traditional open-circuit, cooling towers. Today, many manufacturers actively participate in the CTI Certification Program by voluntarily submitting their open- and closed-circuit cooling tower lines to the scrutiny of the certification process. By the 1950s, galvanized steel had become the principal material of construction for factory-assembled cooling towers. The protective zinc layer of galvanized steel provided effective corrosion protection from the naturally corrosive environment found in service. Combined with an effective water treatment program, galvanized steel cooling towers are designed to provide exceptionally long service life for evaporative cooling equipment.

In the 1970s, EPA regulations restricted the use of chromates, a widely used, highly reliable corrosion inhibitor in many cooling systems, including hvac systems. The resultant changes in water treatment programs were less effective at controlling corrosion rates, thereby increasing maintenance costs and potentially impacting the life of galvanized steel evaporative-cooling equipment. In response, cooling tower manufacturers began using higher grades of galvanized steel for additional corrosion protection and incorporating non-metallic materials, where suitable. Stainless steel components became available as added-cost options for projects desiring extended equipment life.

The need for corrosion protection beyond that provided by galvanized steel alone, without the high cost of stainless steel, was answered in 1981 by the development of special hybrid polymer coating systems for galvanized steel. This cost-effective, additional corrosion protection for galvanized steel is still in widespread use today. Today's leading cooling towers combine the latest in advanced materials technology to achieve the optimum balance between corrosion resistance,

product durability, long life, and cost. Based on their specific function, cooling tower components are designed using the materials with the best combination of corrosion resistance and physical properties.

1.4 Motivation

In this age of industrialization there is continuous growth manufacturing industries, chemical industries, nuclear and thermal power plant. Each of these sector deal with heats and heat transfer. A lots of waste heat is generated. Rejection of this heat is a major concern in all these industries. So this a main motivation factor. Besides this there are few other motivation factor like reducing thermal pollution due to waste heat, to study heat transfer in different mode practically and keen interest to work in power generation sector.

1.5 Thesis Organization

- In chapter one introduction, history of cooling tower and motivation to work in this project has been highlighted.
- In chapter two basic concept on heat transfer, first law and second law of thermodynamics, modes of heat transfer, cooling tower and classification of cooling tower has been discussed.
- In chapter three technical concept of cooling tower is covered.
- In chapter four construction and factor influencing the performance of cooling tower is discussed.
- In chapter five component used in this thesis project is highlighted with brief description.
- In chapter six experimental procedure has been discussed. Chapter seven includes data collection, calculation, result, discussion and recommendation.

Chapter Two

LITERATURE REVIEW

2.1 Basic Concept

The cooling tower are mostly chemical industries, process industries, power plant and heating ventilation and air conditioning where high heat transfer performance and high effectiveness are mostly required. There factors that affect the performance of counter flow cooling tower like water flow rate, air flow rate, fill porosity, water to air ratio, fouling, heat ,leakage in the atmosphere. [] we have worked on cooling tower by using Merkel equation and poppe's equation to calculate effectiveness of cooling tower by considering the effect of water and air flow rate, ambient wet bulb temperature, tower characteristics.

Following are the main objectives:

- To observe the effects of process variables on the outlet temperature of the water. Such as
 1. Inlet water flow
 2. Inlet air velocity
 3. Water flow rate

For this following step needs to be perform

- a. Modeling of cooling tower
- b. Experimental reading and data collection
- c. Effectiveness calculation
- d. Optimization of effectiveness

2.2 First Law of Thermodynamics

Fact about converting mechanical work into heat energy is introduced before many years ago. Normally the unit of heat energy is kcal or kJ. This is the amount of heat required by 1 kg of water to raise its temp by 1°c or 1k. since amount of heat varies with temperatures of water that's why defining particular value of temperature for this unit is worthwhile.

The amount of heat received or rejected by a working body during the process of heating or cooling is given by $q=mc (t_2-t_1)$ where,

q = heat gained or lost by the body, kcal

m =mass of the body, kg

$(t_2 - t_1)$ = temperature rise of body °C or k

c = an experiment factor kcal/kg k

Specific heat the substance is defined as the amount of heat that enters or leaves a unit mass of the substance when it experiences 1 Degree change in temperature. As Specific heat is a function of temperature so,

$$\Delta q = mcdT$$

The product $m \times c$ is separately termed as heat capacity or water equivalent of the body.

Adiabatic index is the ratio of C_p/C_v

C_p for air is 0.240 kcal/kg k

C_v for air is 0.1715 kcal/kg k

We also know $q = W/J$ where

q = quantity of heat in kcal that is converted into work W = work that is obtained at the expense of heat.

J = coefficient of proportionality called mechanical equivalent of heat.

We may summarize the different aspects of thermodynamic work and heat:

Work and heat are not properties of the system. They exist only during interaction between the system and the boundary. They appear when change of state occurs and disappear when the process has been completed.

When a system is undergoing a change of state, work and heat cross the system boundary and properties of the system change.

Work and heat are path functions and inexact differential.

Heat is transferred because of difference in temperature between the system and its surroundings.

Work transfer is however by reasons other than temperature.

Mechanical work is only one form of thermodynamic work and is calculated with the help of equation

$$W = p dv$$

A fluid flow through a pipe of uniform area of cross section and velocity over the cross section is uniform.

Force = pressure intensity \times cross sectional area, $F = pA$

$$\begin{aligned}\text{Work done/sec, } W &= \text{force} \times \text{velocity} \\ &= pAC \\ &= pV\end{aligned}$$

Where c is uniform velocity and v is the volume of gas flowing per second.

The analysis of the steady flow system is based on following assumption:

Rate of mass inflow is same as rate of mass outflow and the mass of the fluid remains constant within the system.

No change in chemical composition of the system and hence no change in chemical energy is involved.

Both at entry and exit the fluid is uniform in composition state and velocity.

Rate at which heat and work traverse the boundaries are constant.

State of fluid at any point is same at all times [1]

2.3 Second Law of Thermodynamics

Statement of second law is impossible to construct an engine working on cyclic process whose sole purpose is to convert all the heat supplied to it into equivalent amount of work”.

According to this law working on cyclic process means there is no change in internal energy for the complete cycle, cannot receive heat from a heat source and delivery work $W=q$.

It was stated that all forms of energy are not equally amenable to transformation which means some forms of energy are more valuable than others. In particular it is known to us that work energy can easily be converted into heat energy like stirring operation. On the other hand it is not possible to convert heat into work easily. It will be realized that large reservoir of heat at room temperature cannot do any work because it cannot transfer heat.

The conditions for a reversible process may be laid down as follows:

- There should be no friction, solid or fluid.
- Heat must be transferred only through an infinitely small temperature difference.

The process in series of the process must proceed in series of equilibrium States for example the process must precede at infinitely slow pace

For this reason we may say that reversibility is neither attainable nor desirable in practice. However it may be used to set a standard efficiency. Endeavour should be made to attend this efficiency whilst still maintaining satisfactory rate of working.

The second law of thermodynamic is directly linked with the thermal efficiency of engine. The efficiency is defined as the ratio of work output from a system to heat input into the system.

But for the restriction put by the second law of thermodynamics it would have been possible to convert all heat into work and achieve an ideal efficiency of hundred percent. However according to second law of thermodynamics it is necessary to have heat sink to which some heat energy is to be rejected does if q_1 and q_2 are heat energy is supplied to and rejected by an engine working on a cyclic process then thermal efficiency is given by [1]

$$\eta_{th} = W \div q_1 = (q_1 - q_2) / q_1$$

The time I turn down the time that time the time that time that time efficiency however does not serve the purpose adequately in case of heat pump and refrigerator the main purpose of heat pump is to supply heat say Q_1 heat source at higher temperature and during this cycle work is supplied to a pump. This is called coefficient of performance or C.O.P.

$$\text{C.O.P (pump)} = q_1 \div W = q_1 / q_1 - q_2$$

In the same way since the purpose of refrigerator is to draw out heat Q_2 from the food stuff with the help of work W the coefficient of performance for refrigerator may be written as:

$$\text{C.O.P (refrigerator)} = q_2 \div W = q_2 / q_1 - q_2$$

It will be realized from the foregoing deliberations that amount of heat transferred by all engines working on Carnot cycle and between the same limits of temperature will be same and hence their efficiencies will be equal. However Carnot cycle consists of reversible process .If an engine works on a cycle consisting of one or more irreversible processes then its efficiency will be different from the Carnot engine. Carnot showed that efficiency of such an engine will always be less than that of Carnot engine. This fact is known as Carnot's theorem and may be stated as follows

- No engine on a cyclic process is more efficient than Carnot engine when working between the same limits of temperature.

2.4 Modes of Heat Transfer

Heat transfer which is the spread of energy from one region to another which is the result of temperature gradient takes place by the following three modes:

- Conduction
- Convection
- Radiation

Heat transmission, in majority of real situations, occurs as a result of combinations of these modes of heat transfer. Example: The water in a boiler shell receives its heat from the fire bed by conducted, convected and radiated heat from the fire to the shell, conducted heat through the shell and conducted and convected heat from the inner shell wall, to the water. Heat always flows in the direction of lower temperature.

The above three modes are similar in that a temperature differential must exist and the heat exchange is in the direction of decreasing temperature; each method, however, has different controlling laws.

2.4.1 Heat Transfer by Conduction:

Conduction is the transfer of heat from one part of a substance to another part of the same substance, or from one substance to another in physical contact with it, without appreciable displacement of molecules forming the substance.

- By lattice vibration:

The faster moving molecules or atoms in the hottest part of a body transfer heat by impacts some of their energy to adjacent molecules.

- By transport of free electrons:

Energy flux is provided by free electron in the direction of decreasing temperature—For metals, especially good electrical conductors, the electronic mechanism is responsible for the major portion of the heat flux except at low temperature.

In case of gases, the mechanism of heat conduction is simple. The kinetic energy of a molecule is a function of temperature. These molecules are in a continuous random motion exchanging energy and momentum. When a molecule from the high temperature region strikes with a molecule from the low temperature area, it drops energy by collisions.

In liquids, the mechanism of heat is nearer to that of gases. However, the molecules are more closely spaced and intermolecular forces come into play

2.4.2 Heat Transfer by Convection

Convection transfers heat within a fluid by mixing of one portion of another.

Convection is applicable only in case of fluid medium. It directly connected with the transport of medium itself. Convection constitutes the microform of the heat transfer since macroscopic particles of a fluid moving in space cause the heat exchange.

This mode of heat transfer is met with in situations where energy is transferred as heat to a flowing fluid at any surface over which flow occurs. This mode is basically conduction in a very thin fluid layer at the surface and then mixing caused by the flow. The heat flow depends on the properties of fluid and is independent of the properties of the material of the surface. [2]

(a)Free or natural convection:

Free or natural convection occurs where the fluid circulates by virtue of the natural differences in densities of hot and cold fluids; the denser portions of the fluid move downward because of the greater force of gravity, as compared with the force on the less dense.[2]

(b)Forced convection:

When the work is done to blow or pump the fluid, it is said to be forced convection

2.4.3 Heat Transfer by Radiation

Radiation is the transfer of heat through space or matter by means other than conduction or convection.

Radiation heat is thought of as electromagnetic waves or quanta (as convenient) an emanation of the same nature as light and radio waves. All bodies radiate heat; so a transfer of heat by radiation occurs because hot body emits more heat than it receives and a cold body receives more heat than it emits. Radiant energy (being electromagnetic radiation) requires no medium for propagation and will pass through a vacuum.

2.5 Cooling Tower

A cooling tower is a device that is used to cool a water stream while simultaneously rejecting heat to the atmosphere. In systems involving heat transfer, a condenser is a device that is used to condense the fluid flowing through it from a gaseous state to a liquid state by cooling the fluid. This cooling to the fluid flowing through a condenser, is generally provided by a cooling tower. Cooling towers may also be used to cool fluids used in a manufacturing process. As a result, we see that cooling towers are commonly used in

1. HVAC (Heating Ventilation and Air-Conditioning) to reject the heat from chillers
2. Manufacturing to provide process cooling
3. Electric power generation plants to provide cooling for the condenser

Cooling tower operation is based on evaporative cooling as well as exchange of sensible heat. During evaporation of cooling in cooling tower, a small amount of the water that is being cooled is evaporated in affecting stream of air to cool the rest of the water. Also when hot water comes in contact with cool air, there is sensible heat transfer whereby the water is cooled. The major amount heat transfer to the air is through evaporative cooling while only about 25% of the heat transfer is through sensible heat. [3]

2.5.1 Types of Cooling Tower [9]

Cooling towers can be classified in many different ways as follows

- Classification based on heat transfer method
 - Wet cooling tower
 - Dry Cooling tower
 - Fluid Cooler
- Classification on the Basis of Shape
 - Package type
 - Field Erected type
- Classification on the Basis of Construction
 - Field Erected
 - Factory assembled
- Classification on The Basis of Air Flow
 - Crossflow
 - Counter flow
- Classification on the basis of Air Draft
 - Atmospheric tower
 - Natural Draft Tower
 - Mechanical Draft Tower
 - Forced Draft
 - Induced Draft
- Classification based on type of Fill
 - Spray Fill
 - Splash Fill
 - Film Fill

2.5.1.1 On the basis of Heat Transfer Mode

Wet cooling towers are the most common type of cooling towers and the ones referred to when talking about cooling towers. As explained earlier, they operate on the principle of evaporative cooling. The water to be cooled and the ambient air come in direct contact with each other. This thesis will look mainly at the performance prediction of wet cooling towers since they are the most widely used.

In a dry cooling tower there is a surface (e.g. tube of a heat exchanger) that separates the water from the ambient air. There is no evaporative cooling in this case. Such a tower may be used when the fluid to be cooled needs to be protected from the environment. In a fluid cooler water is sprayed over tubes through which the fluid to be cooled is flowing while a fan may also be utilized to provide a draft. This incorporates the mechanics of evaporative cooling in a wet cooling tower while also allowing the working fluid to be free of contaminants or environmental contact.

2.5.1.2 On the Basis of Shape

Package type cooling towers are preassembled and can be easily transported and erected at the location of use. These are generally suitable for applications where the heat load to be rejected is not very large (most HVAC and process load applications). Field erected type of towers are usually much larger to handle the larger heat rejection loads and are custom built as per customer requirements. Most of the construction /assembly of the tower takes place at the site where the tower will be located.

This thesis will be to build a model that predicts the performance of package type towers. Although the performance of field erected type towers may be similar to package type towers, the predicted performance may not be very accurate as a result of the unique and requirement specific construction of field erected type towers.

2.5.1.3 On the Basis of Construction

Field erected towers are those on which the primary construction actively takes place at the site of ultimate use. All large towers and many small towers are prefabricated, piece-marked and shipped to the site for final assembly. Labor or supervision for final assembly are generally provided by the manufacturer.

Factory assembled towers undergo virtually complete assembly at the point of manufacture, where upon they are shipped to the site as few sections as the mode of transportation will permit. Factory assembled towers are also known as “packaged” or “unitary” towers.

2.5.1.4 On the Basis of Air Flow

In a crossflow tower the direction of air flow is perpendicular to that of the water flow i.e. the water flows vertically downward through the fill, while the air flows horizontally through the fill. In a counter flow tower, the direction of air flow is directly opposite to that of the water flow i.e. as the water flows vertically downwards through the fill, the air flows vertically upwards through it. Figure shows the configuration of crossflow and counter flow cooling tower configurations.

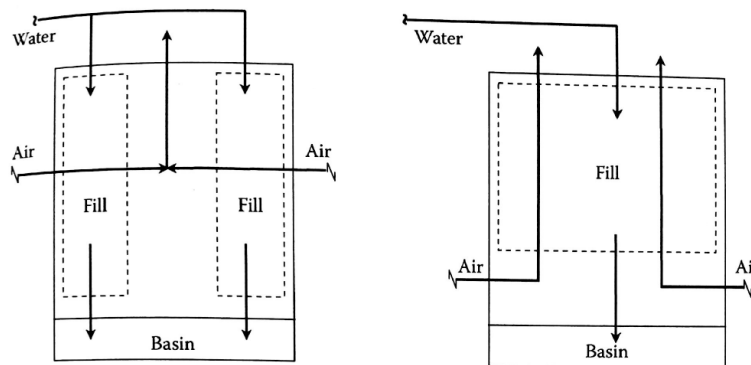

Figure 2.1: Configuration of cross flow and counter flow cooling tower

2.5.1.5 On the basis of Air Draft

In an atmospheric tower the air enters the tower through louvers driven by its own velocity. This kind of a tower is inexpensive. Since the performance is greatly affected by wind conditions it is largely inefficient and is seldom used when accurate and consistent cold water temperatures are required.

A natural draft tower (also known as hyperbolic cooling tower) is similar to an atmospheric tower in that there is no mechanical device to create air flow through the tower. However, it is dependable and consistent unlike an atmospheric tower. The air flow through the tower is a result of the density differential between hot and less dense air inside the tower as compared to the relatively cooler and denser ambient air outside the tower. The hot air rises up through the tower while cool ambient air is drawn in through inlets at the bottom of the tower. Natural draft towers are extensively used in electric power generation plants and areas where there is higher relative humidity. These towers are much more expensive as compared to other tower types and conspicuous by their hyperbolic shape which is so designed because

- The natural upward draft is enhanced by such a shape
- This shape provides better structural strength and stability

Sometimes natural draft towers are equipped with fans to augment the air flow and are referred to as fan assisted natural draft towers or hybrid draft towers. Mechanical draft towers have one or more fans that are used to move the air through the tower to provide predictable and consistent performance making them the tower of choice in most HVAC and process applications. A mechanical draft tower can be subdivided in two types, namely, forced draft towers and induced draft towers. The tower is termed a forced draft tower if the fans are arranged so as to blow air into the tower. Thus there is a positive pressure in the tower fill as compared to the outside. In this case the fans are generally located at the point where the air enters the tower. The tower is termed an induced draft tower if the fans are arranged so as to push air out of the tower. Thus there is a negative pressure in the tower fill as compared to outside. The fan is located at the point where the air leaves the tower.

Figure shows the configuration of the cooling tower for forced draft and induced draft fans.

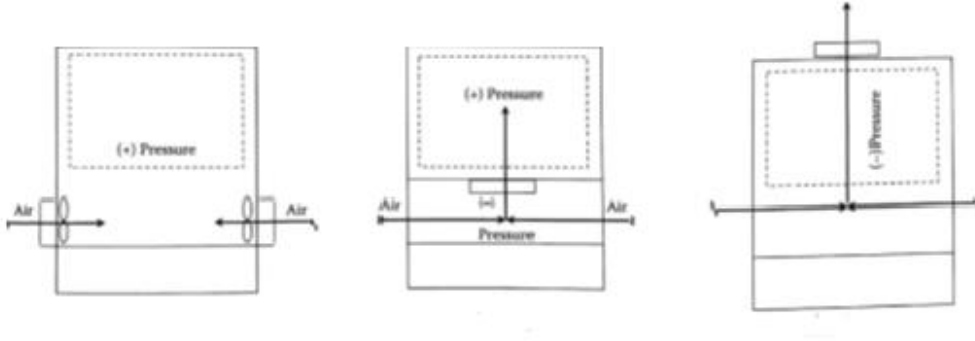

Figure 2.2: Configuration of forced draft and induced draft fans

2.5.1.6 On the basis of type of fill

In a spray fill tower the water is broken down into small droplets so that the area of contact between the water surface and air is increased. So in a way spray fill is not really a fill because there is no packing in the tower. Small droplets of water are created by spraying through nozzles, which are contained within the tower casing, through which there is airflow. The drawbacks of this kind of a fill are low efficiency, large tower size and large airflow requirement.

In a splash fill tower, there are slats of wood, PVC or ceramic material over which the water cascades down the tower. As the water splashes over the slats, it forms small droplets which allow for better tower performance. A splash fill is shown in Figure.

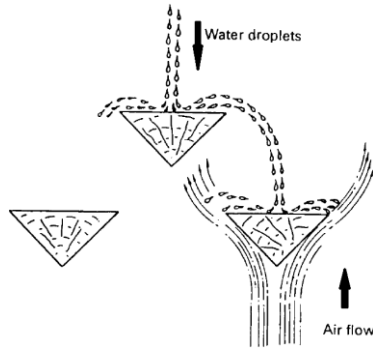

Figure 2.3: A splash fill configuration

In a film fill, large surface area is provided for the water to flow over, which causes it to form a thin film. Because of this large contact area between the water surface and air, efficient evaporative cooling is seen. In this kind of a tower, the pressure drop as the air flows through the tower is lower as compared to the previous types and thus lesser fan power is needed to move the air through the tower. An example of a film fill for a cooling tower is shown in Figure Film fill is less expensive and more efficient than splash fill and has resulted in its widespread use in cooling towers.

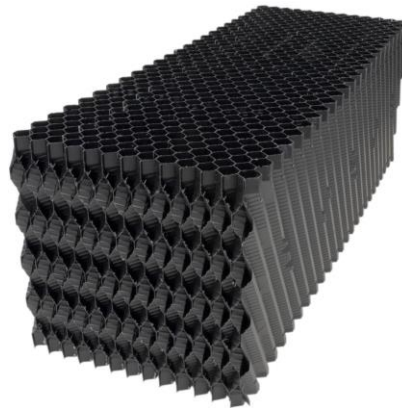

Figure 2.4: A film fill configuration

Chapter Three

METHODOLOGY

3.1 Mathematical Modeling

Merkel developed a theory for cooling tower heat transfer process based on enthalpy difference as driving force.

Each water particle is assumed to be surrounded by air film. The enthalpy difference between the film of air and surrounding air is driving force of heat transfer in cooling tower. The integrated form of Merkel equation is [11]

$$Ldt = kadv(h-h')= Gdh \quad (1)$$

$$\frac{KaV}{L} = \int_{T_{water\ out}}^{T_{water\ in}} \frac{dT}{h'-h} \quad (2)$$

$$\frac{KaV}{G} = \int_{h_1\ at\ A}^{h_2\ at\ B} \frac{dh}{h'-h} \quad (3)$$

Where,

k= mass transfer coefficient, (kg_{water}/m^2s) ; $\frac{dry\ air\ (kg)}{water\ (kg)}$

a = contact area per unit volume, (m^2/m^3)

V= active cooling volume, (m^3/m^2)

L= water flow rate, (kg/m^2s)

h'= enthalpy of saturated air at temperature, (kJ / kg)

h= enthalpy of air steam, (kJ / kg)

G= air flow rate, (kg/sm^2)

Integrated value or $\frac{KaV}{L}$ is known as tower characteristics.

Let us see cooling diagram of counter flow cooling tower.

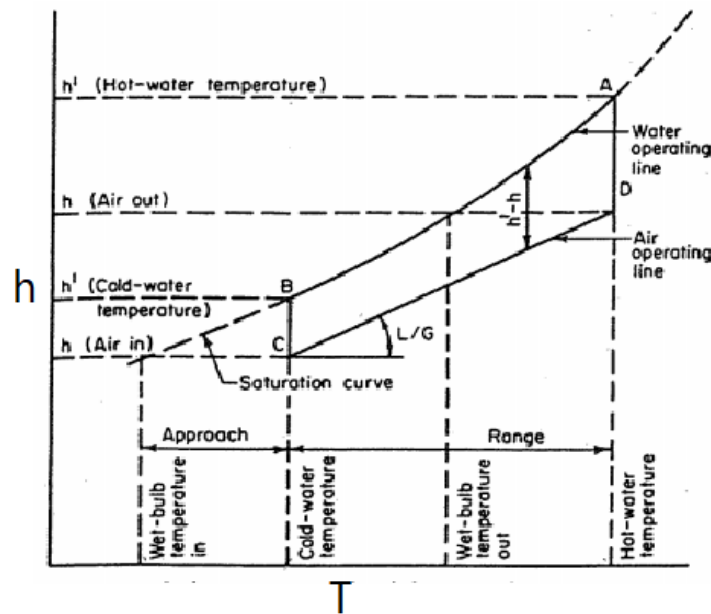

Figure 3.1: Cooling Tower Process Heat Balance [11]

This diagram is important to understand cooling process take place in cooling tower. C is the point of cold air in. So the enthalpy difference between point B and C ($h-h'$) is the driving force for heat transfer taking place. Air takes heat from water and reach along straight line up to D. And slope of straight line (L/G) which is the ratio of total mass flows of water and dry air in cooling tower.

The coordinates of figure indicates directly enthalpy and temperature of any point on the Water operating line. And on air operating line, temperature and enthalpy is found by projecting the point horizontally to saturation curve then vertically to saturation curve, then velocity of saturation curve.

$$\frac{L}{G} = \frac{\text{kg of water circulated /m}^2\text{s}}{\text{kg of dry air/m}^2\text{s}} \quad (4)$$

When $\frac{L}{G}$ decreases, CD approaches towards BA.

The Maximum $\frac{L}{G}$ & minimum air flow rate will occur when water inlet temperature & air outlet wet bulb temperature are equal. There fore $(\frac{L}{G})_{\text{max}}$ is the slope of line that connects A with C in the figure.

Inlet Driving force = BC = $(h' - h)$ inlet

Outlet Driving force = AD = $(h' - h)$ outlet

So the driving force for cooling process in cooling tower is the vertical difference between the water operating line and air operating line. [11]

So tower characteristics,

$$\begin{aligned} \text{NTU} &= \frac{KaV}{L} = \int_{T_{\text{water out}}}^{T_{\text{water in}}} \frac{dT (C_p=1)}{h' - h} \\ &= \int_{T_{\text{water out}}}^{T_{\text{water in}}} \left(\frac{1}{h' - h} \right) dT \end{aligned} \quad (5)$$

This value $\frac{KaV}{L}$ is called tower characteristics which vary with $\frac{L}{G}$.

Cooling range & Cooling Tower Approach:

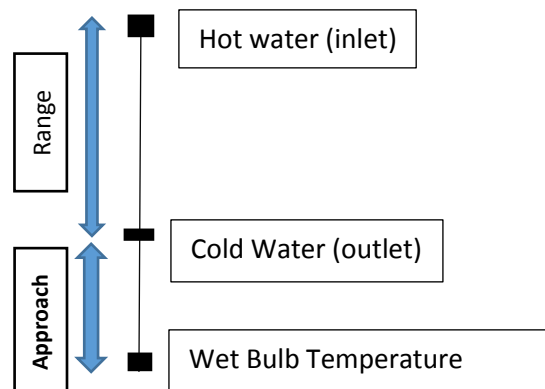

Cooling Range:

Difference between the water inlet & outlet temperature is known as cooling range.

$$R_{th} = T_{wi} - T_{wo} \quad (6)$$

Cooling Tower Approach:

The difference between water outlet temperature and entering air wet bulb temperature.

$$R_a = T_{wi} - T_2 \quad (7)$$

NTU of Transfer Unit (NTU):

NTU stands for number of transfer unit. It means cooling tower characteristics [11]

$$\frac{KaV}{L} = \int_{t_{water\ out}}^{t_{water\ in}} (h' - h) dT \quad (8)$$

NTU can be evaluated by following methods [11]

1. Let us assume humidification is an adiabatic process.

Now based on mass transfer

$$NTU = \ln\left(\frac{H_{sat\ inlet} - H_{air\ in}}{H_{sat\ inlet} - H_{air\ out}}\right) \quad (9)$$

Base of heat transfer,

$$NTU = \ln\left(\frac{T_{air\ in\ dry} - T_{sat\ inlet}}{T_{air\ out\ dry} - T_{sat\ inlet}}\right) \quad (10)$$

On psychometric chart note the following: [11]

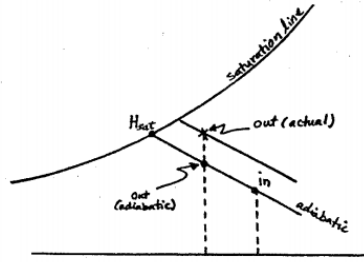

Heat load:

Heat load is the total load that is removed from the cooling water per unit time. Hence,

Heat load=heat lost to the atmosphere

This can be found as follows:

- a. Based on inlet and out cooling water temperature.

$$\text{Heat load, } Q_1 = LC_{p_w}(T_{w_i} - T_{w_o}) \tag{11}$$

- b. Based on heat gained by air.

$$\text{Heat load, } Q_2 = G(h_1 - h_2) + \dot{m}_{\text{water loss}} \alpha_{\text{avg}} \tag{12}$$

Assuming air flow rate is constant.

$$\dot{m}_{\text{water loss}} \alpha_{\text{avg}} = \text{Evaporation loss}$$

Where, $\dot{m}_{\text{water loss}}$ = make up water

X_{avg} = latent heat of water

$$\text{Cooling Efficiency} = \frac{\text{Range}}{\text{Approach}} \times 100\% \tag{13}$$

Rate of water loss and the make up:

Cooling tower water loss is due to evaporation loss mainly. Besides there is drift loss, windage, blow down, leakage etc.

$$\text{The rate of water loss (lb/hr.)} = (\text{Humidity Out} - \text{Humidity in}) \tag{14}$$

The water that is added to the circulating water system to replace the water lost is called make up water.

Rate of make-up water = rate of the loss

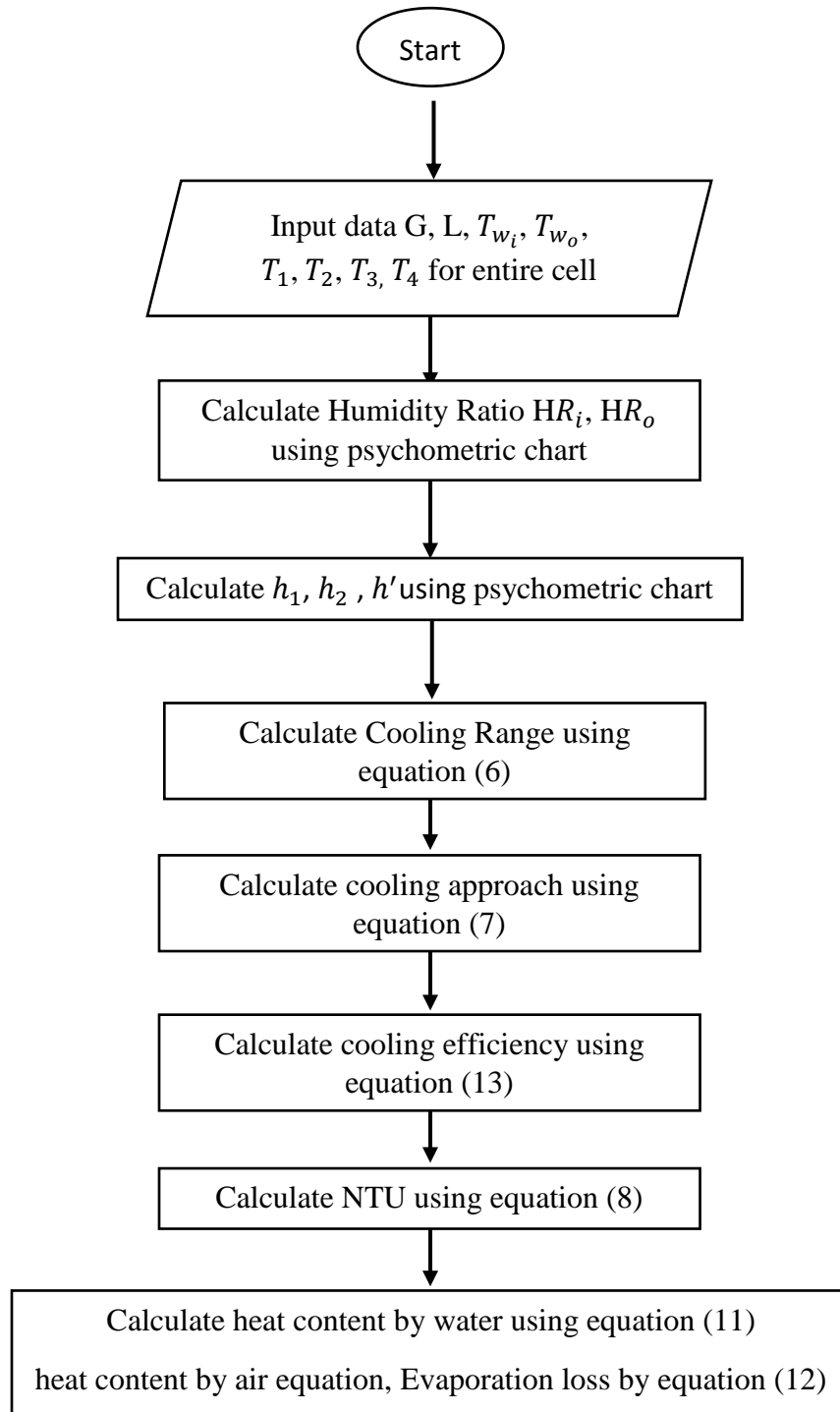

3.2 Parameters

Dry-bulb temperature (DBT):

The dry-bulb temperature is the temperature indicated by a thermometer exposed to the air in a place sheltered from direct solar radiation.

Wet-bulb temperature (WBT):

The wet-bulb temperature is the temperature a percent of air would have if it were cooled to saturation (100% relative humidity) by the evaporation of water into it, with the latent heat being supplied by the parcel.

Relative humidity:

The ratio of the vapour pressure of moisture in the sample to the saturation pressure at the dry bulb temperature of the sample is called relative humidity.

Dew point temperature:

The saturation temperature of the moisture present in the sample of air, it can also be defined as the temperature at which the vapor changes into liquid (condensation).

Specific Humidity:

Specific humidity is defined as the proportion of the mass of water vapor per unit mass of the moist air sample (dry air plus the water vapour); it is closely related to humidity ratio and always lower in value.

Absolute humidity:

The mass of water vapour per unit volume of air containing the water vapour is called absolute humidity. This quantity is also known as the water vapour density.

Specific enthalpy:

Specific enthalpy - h - (J/kg, Btu/lb) of moist air is defined as the total enthalpy (J, Btu) of the dry air and the water vapor mixture - per unit mass (kg, lb) of dry air.

Specific volume:

Specific volume indicates the space occupied by air. It is the inverse of density and is expressed as a volume per unit weight.

3.3 Consideration

- Range is the difference between the cooling tower water inlet and outlet temperature.
- "Approach" is the difference between the cooling tower outlet cold water temperature and ambient wet bulb temperature.
- Cooling tower effectiveness (in percentage) is the ratio of range, to the ideal range, i.e., difference between cooling water inlet temperature and ambient wet bulb temperature, or in other words it is = $\text{Range} / (\text{Range} + \text{Approach})$.
- Cooling capacity is the heat rejected in kCal/hr or TR, given as product of mass flow rate of water, specific heat and temperature difference.
- Evaporation loss is the water quantity evaporated for cooling duty.
Evaporation loss, $Q_3 = \Delta w \times \dot{m}_a \times 2268 \text{ (Kj/kg)}$
- Liquid/Gas (L/G) ratio, of a cooling tower is the ratio between the water and the air mass flow rates.

3.4 Component

3.4.1 Cooling Tower

A cooling tower is a heat rejection device that rejects waste heat to the atmosphere through the cooling of a water stream to a lower temperature. Cooling towers may either use the evaporation of water to remove process heat and cool the working fluid to near the wet-bulb air temperature or, in the case of closed circuit dry cooling towers, rely solely on air to cool the working fluid to near the dry-bulb air temperature.



Figure 3.2: Bottled induced draft cooling tower

Manufacturer: **Artisan Craft (BD) Ltd**

Type: Mechanical Induced Draft Counter Flow Bottle Type Cooling Tower

Model: ART-10

Material of construction:

- Basin: FRP
- Casing: FRP
- Access door: NIL
- Fan stack: NIL
- Distribution basin: NIL
- Louver: Al net
- In-fill: PVC
- Eliminator: FRP
- Hardware: H.D.G.S.
- Ladder: H.D.G.S.
- Safety cage: NIL
- Safety guard rail: NIL
- Bolts and nuts: H.D.G.S.

Fan assembly and motor:

- Type of fan: Axial
- Fan diameter: 482mm
- Fan speed: 1440rpm
- No of fan blade: 4
- MOC fan blade: Nylon
- Air flow rate: 5100 m³/hr
- Motor type: TEFC
- Motor rating: 0.18KW
- Pole no: 4
- Motor rpm: 1440
- Voltage/ Phase/ Hz: 38 V / 3phase / 50Hz
- Ingress protection rating: IP55
- Insulation: Class F

Water distribution system:

- Sprinkler distribution system
- Inlet pipe: DN40
- Outlet pipe: DN40
- Float valve: DN15
- Make up: DN25
- Overflow: DN25
- Drain: DN15

Physical data:

- Diameter: 1050mm
- Height: 1605mm
- Dry weight: 55kg

Operating weight: 137kg

3.4.2 Pump

A pump is a device that moves fluids (liquids or gases) by mechanical action. Pumps can be classified into three major groups according to the method they use to move the fluid: direct lift, displacement, and gravity pumps. Pumps operate by some mechanism and consume energy to perform mechanical work by moving the fluid. Pumps operate via many energy sources, including manual operation, electricity, engines, or wind power, come in many sizes, from microscopic for use in medical applications to large industrial pumps.

Mechanical pumps serve in a wide range of applications such as pumping water from wells, aquarium filtering, pond filtering and aeration, in the car industry for water-cooling and fuel injection, in the energy industry for pumping oil and natural gas or for operating cooling towers.



Figure 3.3: Centrifugal pump

Specification:

Power : 0.5 hp

Total head : 30 meter

Static head : 6 meter

Voltage : 220 v

Frequency : 50 hz

3.4.3 Reservoir

A reservoir that can hold hot water to be cooled above the heat transfer surface. The water is forced down through nozzles into the fill by gravity where it is then cooled by the air. A drum of 24 inch length and 22 inch diameter is used as heating tank.

3.4.4 Flow Meter

A flow meter is a device used to measure the flow rate or quantity of a gas or liquid moving through a pipe. Flow measurement applications are very diverse and each situation has its own constraints and engineering requirements. We have used a “Variable Area Flow Meter (Rotameter)”. These flow meters are process-proven flow meters, for maximum repeatability and reliability. [4]

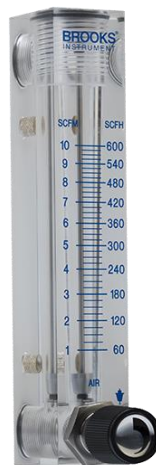

Figure 3.4: Plastic variable area flow meter

Plastic variable area flow meter:

- Most cost-effective solution for non-corrosive and low pressure applications
- Excellent measurement repeatability which provides process stability and consistency
- Fluid Type: Gas, Liquids
- Accuracy: 2-10% FS
- Max Pressure: 100 psig
- Max Temperature 72°C (160° F)
- Output Type: Visual Indication

3.4.5 Thermocouple

A thermocouple is a simple, robust and cost-effective temperature sensor used in a wide range of temperature measurement processes. It consists of two dissimilar metal wires, joined at one end. When properly configured, thermocouples can provide measurements over a wide range of temperatures.

There are many types of thermocouples, each with its own unique characteristics in terms of temperature range, durability, vibration resistance, chemical resistance, and application compatibility. Type J, K, T, & E are “Base Metal” thermocouples, the most common types of thermocouples. Type R, S, and B thermocouples are “Noble Metal” thermocouples, which are used in high temperature applications. [6]



Figure 3.5: Thermocouple Sensor [5]

3.4.6 Humidity Sensor

Humidity Sensors are very important devices that help in measuring the environmental humidity. Technically, the device used to measure the humidity of the atmosphere is called Hygrometer. Humidity Sensors or Hygrometers can be classified based on the type of humidity it is used for measuring i.e.

Absolute Humidity (AH) sensors or Relative Humidity (RH) sensors. Humidity Sensors can also be classified based on the parameter used for measuring Humidity I.e. Capacitive Humidity Sensors, Electrical Conductivity (or Resistive) Humidity Sensors and Thermal Conductivity Humidity Sensors. There are other types of Humidity Sensors or Hygrometers like Optical Hygrometer, Oscillating Hygrometer and Gravimetric Hygrometer.



Figure 3.6; Humidity sensor

3.4.7 Anemometer

An anemometer is an instrument used to measure the speed or velocity of air (gases) either in a contained flow, such as airflow in a duct, or in unconfined flows, such as atmospheric wind. To determine the air velocity, anemometers detect change in some physical property of the fluid or the effect of the fluid on a mechanical device inserted into the flow.



Figure 3.7: Anemometer

3.4.8 Thermocouple Controller

As the name implies, a thermocouple controller is an instrument used to control temperatures, mainly without extensive operator involvement. A controller in a temperature control system will accept a temperature sensor such as a thermocouple or RTD as input and compare the actual temperature to the desired control temperature, or set point. It will then provide an output to a control element. A good example would be an application where the controller takes an input from a temperature sensor and has an output that is connected to a control element such as a heater or fan. [7]



Figure 3.8: Thermocouple Controller [7]

3.4.9 Arduino

Arduino is an open-source platform used for building electronics projects. Arduino consists of both a physical programmable circuit board (often referred to as a microcontroller and a piece of software, or IDE (Integrated Development Environment) that runs on your computer, used to write and upload computer code to the physical board.

The Arduino platform has become quite popular with people just starting out with electronics, and for good reason. Unlike most previous programmable circuit boards, the Arduino does not need a separate piece of hardware (called a programmer) in order to load new code onto the board – you can simply use a USB cable. Additionally, the Arduino IDE uses a simplified version of C++, making it easier to learn to program. Finally, Arduino provides a standard form factor that breaks out the functions of the micro-controller into a more accessible package. [8]



Figure 3.9: Arduino Circuit

3.4.10 Black Soot(Ink)

Soot includes the fine **black** particles, chiefly composed of carbon, produced by incomplete combustion of coal, oil, wood, or other fuels. **Soot** can consist of acids, chemicals, metals, soils, and dust. We have used ink powder, which is the mixture that is used in laser printer and photo copier. These are mostly granulated plastic, mixed with carbon powder and iron oxide. Nowadays tonner have developed containing poly propylene, fumed silica and various mineral for triboelectrification. The specific polymer used varies by manufacturer but can be a styrene acrylate copolymer a polyester resin, a styrene butadiene copolymer, or a few other special polymers. Toner formulations vary from manufacturer to manufacturer and even from machine to machine. In typical formulation granule size and melting point vary the most. Originally the particle size of the

toner averaged 14 to 16 micrometer or greater. To improve image resolution, particle size was reduced, eventually reaching about 8 - 10 micrometer for 600 dots per inch resolution. Further reduction in particle size producing further improvement in resolution are being developed through the application of new technologies such as Emulsion Aggregation. [13]



Figure 3.10: Black Soot(Ink)

Chapter Four

Experimental Set Up and Procedure

4.1 Developed Experimental Setup



(Front View)



(Top View)

Figure 4.1: Developed Experimental Setup

4.2 Schematic Diagram

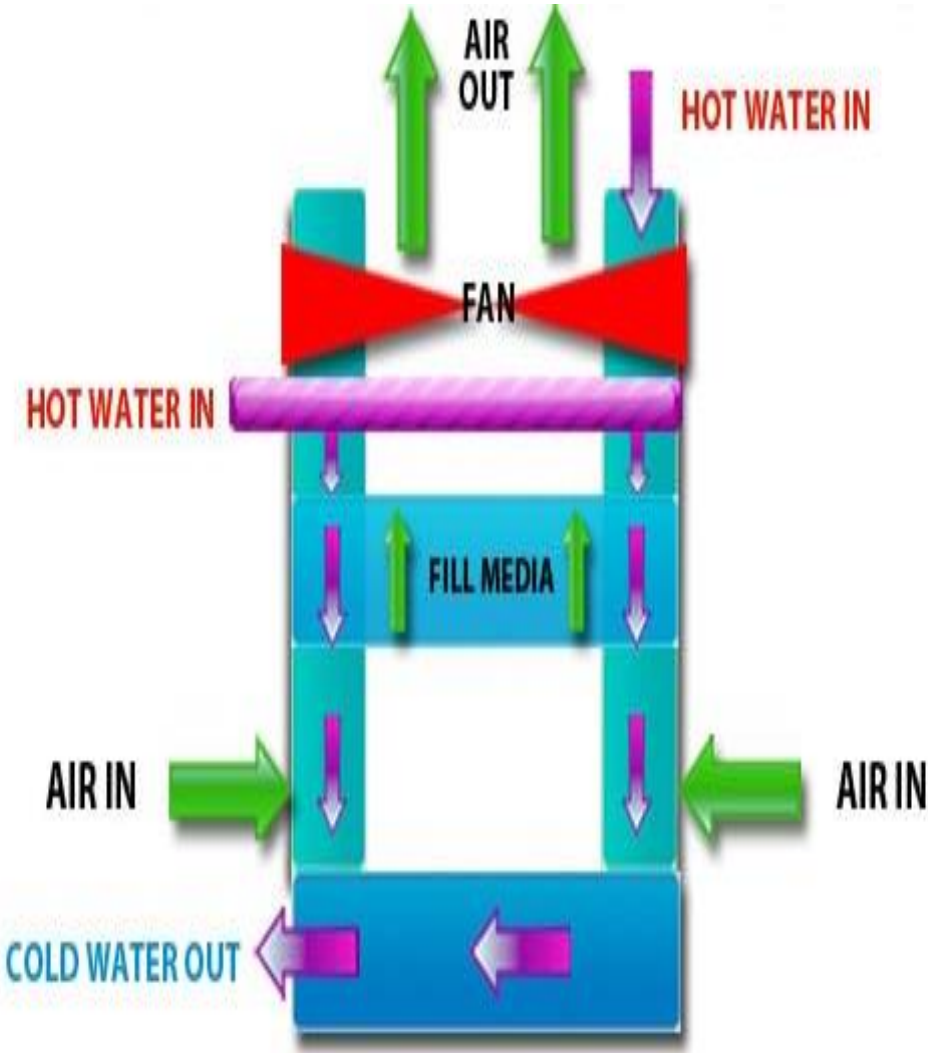

Figure 4.2: Schematic Diagram of Induced Draft Counter Flow Cooling Tower

4.3 Water Circuit:

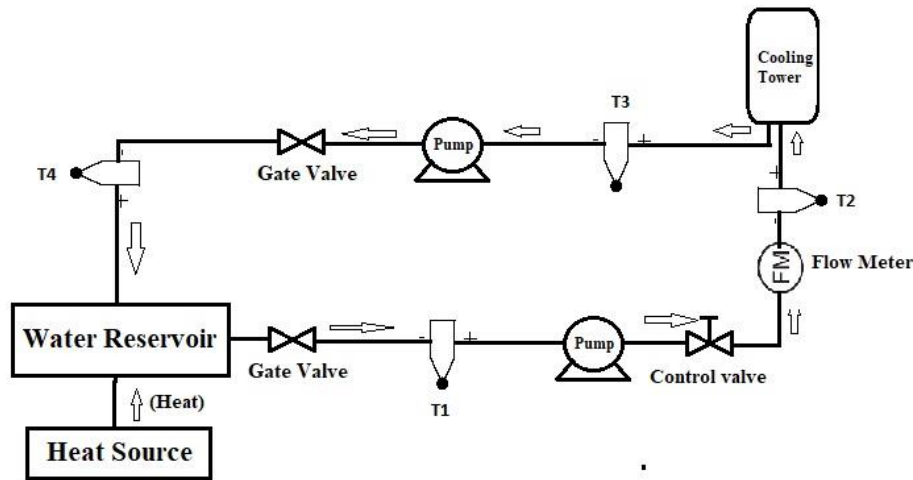
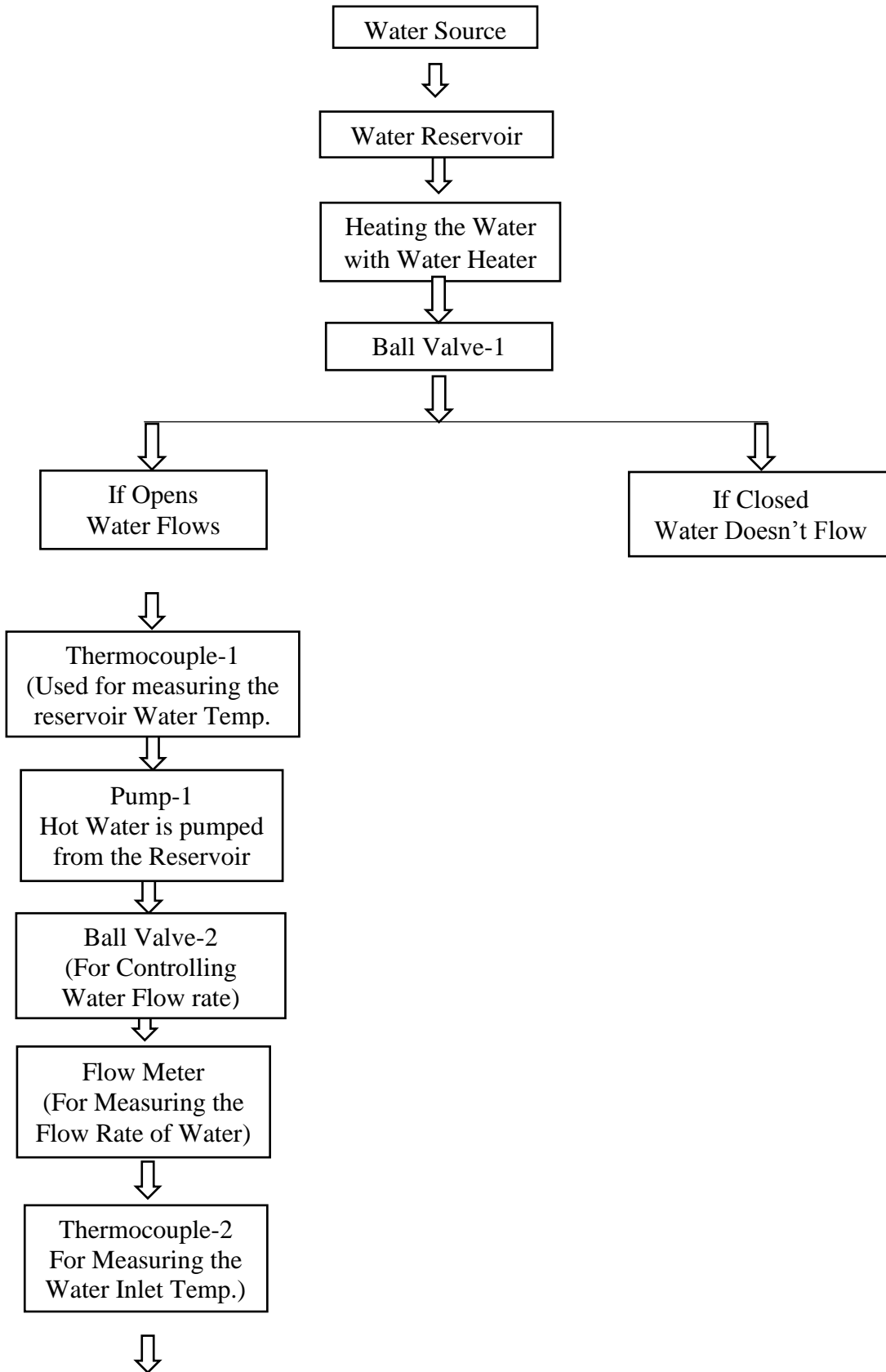

Figure 4.3: Water Circuit

Description:

In this circuit a heat source is used to heat the water present in the reservoir. Here as a heat source gas burner and immersion rod is used. When the water being heated then the flow started. A gate valve is used to control the speed of the water. Just after gate valve a thermocouple is placed to measure the inlet hot water temperature of the water. A pump is used to circulate the flow of water and another gate valve is used to control the speed of the water. A flow meter is used to measure the flow rate of the water and a thermocouple is used to measure the inlet hot water temperature once again before it passes through cooling tower. During passes through cooling tower the temperature of the hot water is reduced. Then outlet temperature of cold water is measured through thermocouple just after the water passed through cooling tower. Again a pump is used to ensure the circulation of water through pipe and a gate valve is used to control the speed of the water. Then cold water temperature is measured once again and water returns to reservoir and cycle continues.

Flow Chart:



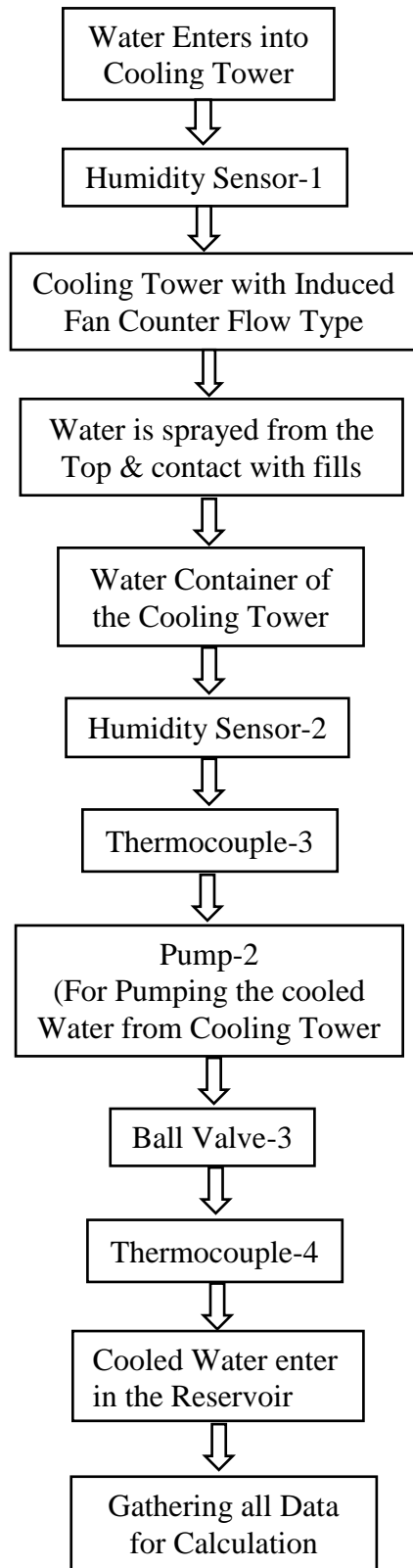

4.4 Air Circuit

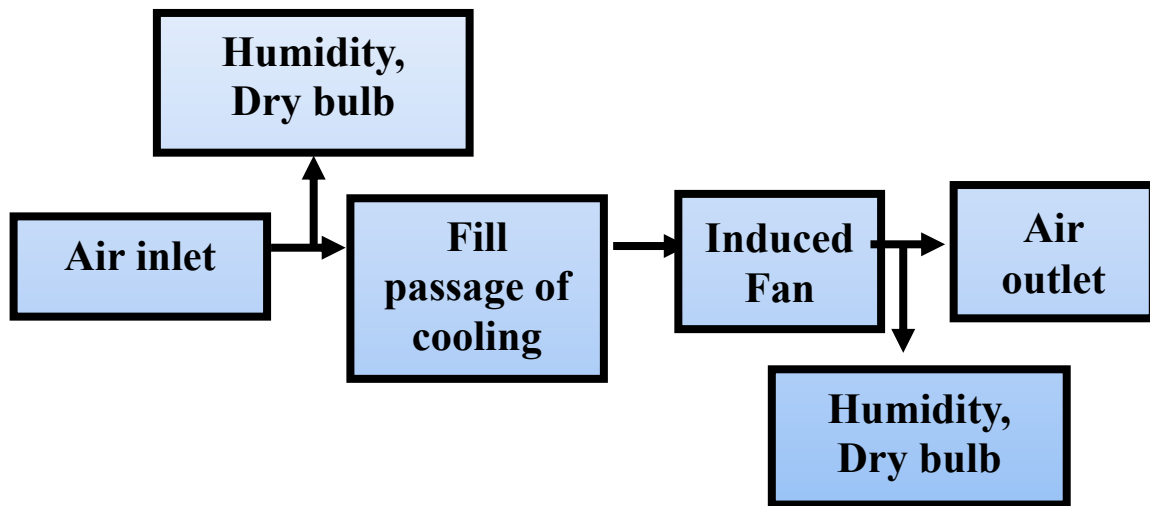

Figure 4.4: Air Circuit

Description:

Air enters through the lower passage of the cooling tower, while entering through the passage there is a dry bulb sensor which gives us the value of humidity of air entering the passage. Continuous air goes through the fill of the cooling tower and it cools down while the induced fan dissipates the heat from the air. Heated air is then goes out through the upper portion of the cooling tower and into the atmosphere. With the help of another dry bulb sensor we get the value of humidity of the air going out in the atmosphere.

4.5 Water Properties Measurement

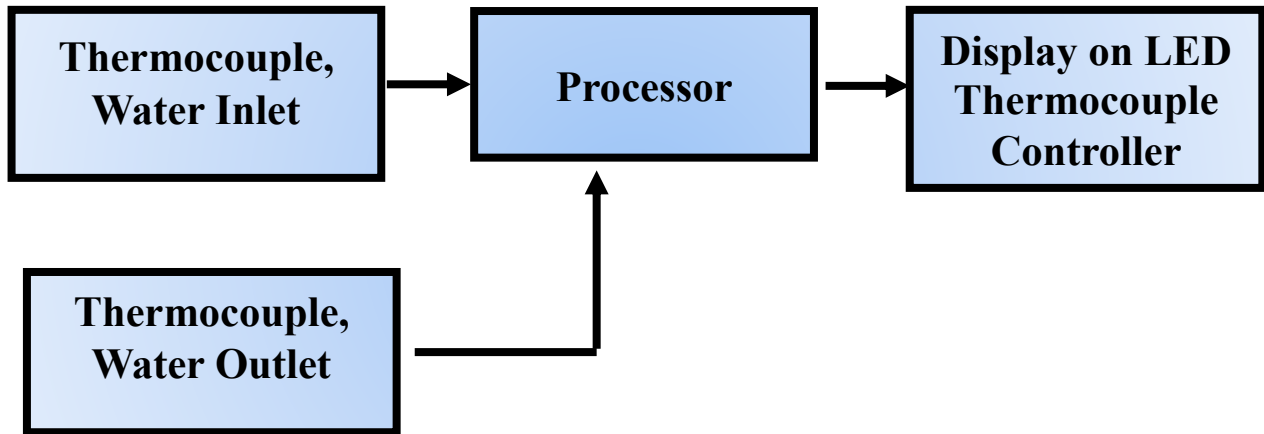

Figure 4.5: Water Properties Measurement Chart

Description:

Water enters through the inlet of cooling tower from a reservoir via a pump of 0.5 hp capacity. There is a water proof temperature sensor which gives us the reading of temperature. An arduino (which is an open source computer hardware and software company, project and user community that designs and manufactures single-board microcontrollers and microcontroller kits for building digital devices and interactive objects that can sense and control objects in the physical world) is used here. The water proof sensor which is connected with the arduino gives us the water properties of the inlet water and displays on the computer screen. Another water proof temperature sensor is attached with the outlet and that is connected with the arduino and gives us the water properties of the outlet water in the computer display.

4.6 Air properties measurement

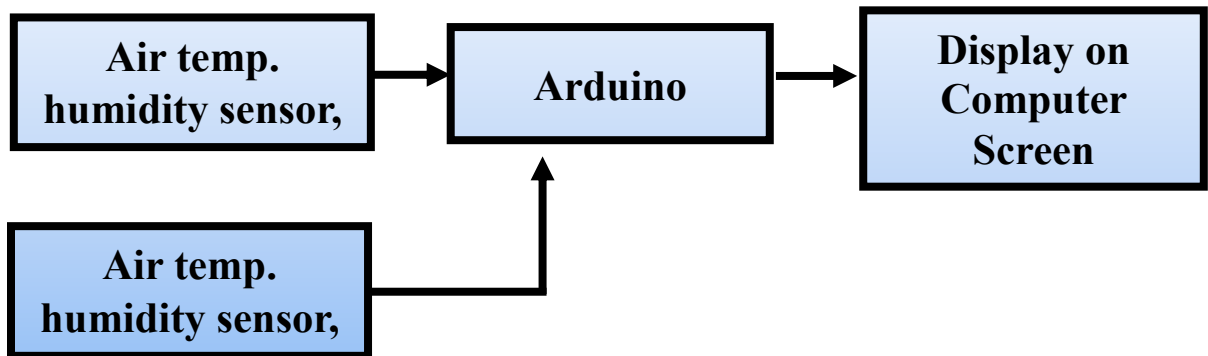

Figure 4.6: Air Properties Measurement Chart

Description:

Air enters through the lower part of the cooling tower and through an air temperature humidity sensor (which is connected with an arduino) we get the air properties at the inlet in the computer display. Another air temperature humidity sensor is at the upper portion of the cooling tower connected with the arduino gives us the air properties at the outlet in the computer display.

-
2. Code is attached in Appendix [B3]
 3. Output of the Program in Appendix [C1] & [C2]

4.7 Data Collection & Calculation

4.7.1 **Data Collection:** Appendix-A

4.7.2 **Calculation:**

1. Cooling Range: using Equation-(6)
2. Cooling Approach: using Equation-(7)
3. Cooling Efficiency: using Equation-(13)
4. L/G : using Equation-(4)
5. NTU: using Equation-(5)
6. Change in Specific Humidity, = $SH_o - SH_i$
7. Make up Water, $M_w = \Delta w \times \dot{m}_a$
8. % Make up Water = $\frac{\Delta w \times \dot{m}_a}{\dot{m}_w}$
9. Change in Heat Content Water, $Q_1 = \dot{m}_w \times c_p \times \Delta T$
10. Change in Heat Content Air, $Q_2 = \dot{m}_a (ha_o - ha_i)$
11. Evaporation loss, $Q_3 = \Delta w \times \dot{m}_a \times l_f$

4.7.3 **Calibration:** Calibration has been shown in Appendix B1 & B2

Table 4.1:

Result: Induced Draft Cooling Tower

Observation	Cooling Range + Approach, R_{th} (°C)	Cooling Range, R_a (°C)	Cooling efficiency η %	Change in sp. Humidity, Δw (kg/kg)	Make up water (m ³ /hr)	% make up water	Change in Heat Content Water, Q_1 (kJ/kg)	Change in Heat Content Air, Q_2	Evaporation Loss, Q_3 (kJ/kg)	NTU	L/G
1	9	9	55.55	1.1×10^{-3}	1.04×10^{-4}	.346	6.3	3.017	2.36	.127	.45
2	19.2	6	46.87	9×10^{-4}	8.5×10^{-4}	.197	16.25	2.59	1.93	.086	.42
3	13.7	5	29.19	5×10^{-4}	4.7×10^{-4}	.118	6.72	1.65	1.07	.188	.36
4	12.2	5	49.18	9×10^{-4}	8.54×10^{-4}	.232	9.25	2.26	1.93	.158	.39
5	11	4	54.54	9×10^{-4}	8.514×10^{-4}	.251	8.57	2.7	1.93	.212	.32

Table 4.2:

Result: Natural Draft Cooling Tower (Collected from other group)

Observation	Cooling Range + Approach, R_{th} (°C)	Cooling Range, R_a (°C)	Cooling efficiency η %	Change in sp. Humidity, Δw (kg/kg)	Make up water (m ³ /hr)	% make up water	Change in Heat Content Water, Q_1 (kJ/kg)	Change in Heat Content Air, Q_2 (kJ/kg)	Evaporation Loss, Q_3 (kJ/kg)	NTU	L/G
1	16.8	5	29.76	6×10^{-4}	2.2×10^{-4}	0.05	9.11	0.62	0.49	.123	1.30
2	15.9	5	31.45	1.7×10^{-4}	5.1×10^{-4}	0.10	8.4	1.05	1.17	.089	1.09
3	11.8	2	16.34	1×10^{-4}	3.6×10^{-4}	.099	3.08	1.01	.825	.083	1.28
4	10.7	2	18.7	7×10^{-4}	2.5×10^{-4}	.075	2.84	.746	.577	.055	1.00
5	10.8	1	9.26	3×10^{-4}	1.1×10^{-4}	.036	1.26	.633	.248	.068	0.93

Table 4.3:
Result: Induced Draft Cooling Tower with Ink (300ml/110L)

Observation	Cooling Range + Approach, R_{th} (°C)	Cooling Range, R_a (°C)	Cooling efficiency η %	Change in sp. Humidity, Δw (kg/kg)	Make up water (m ³ /hr)	% make up water	Change in Heat Content Water, Q_1 (kJ/kg)	Change in Heat Content Air, Q_2 (kJ/kg)	Evaporation Loss, Q_3 (kJ/kg)	NTU	L/G
1	21.3	9	42.25	365×10^{-6}	3.45×10^{-4}	0.073	17.65	1.37	0.78	0.101	0.494
2	16.4	8	48.78	544×10^{-6}	5.14×10^{-4}	0.118	14.55	0.75	1.16	0.132	0.455
3	12.4	7	56.45	360×10^{-6}	3.40×10^{-4}	0.085	11.76	1.38	0.77	0.175	0.423
4	10	6	60.00	1.73×10^{-4}	1.64×10^{-4}	0.045	9.25	0.70	0.37	0.223	0.388
5	9.3	6	64.51	330×10^{-6}	3.12×10^{-4}	0.093	8.40	1.39	0.70	0.228	0.359

Table 4.4:
Natural Draft Cooling Tower with Ink (300ml/110L) (Collected from other group)

Observation	Cooling Range + Approach, R_{th} (°C)	Cooling Range, R_a (°C)	Cooling efficiency η %	Change in sp. Humidity, Δw (kg/kg)	Make up water (m ³ /hr)	% make up water	Change in Heat Content Water, Q_1 (kJ/kg)	Change in Heat Content Air, Q_2 (kJ/kg)	Evaporation Loss, Q_3 (kJ/kg)	NTU	L/G
1	21.4	5	23.36	20×10^{-5}	72.8×10^{-6}	0.015	9.8	0.13	0.16	0.055	1.28
2	16.0	5	31.25	16×10^{-5}	58.24×10^{-6}	0.013	9.09	0.27	0.13	0.085	1.18
3	12.1	4	33.05	21×10^{-5}	7.6×10^{-5}	0.019	6.72	0.27	0.17	0.1	1.1
4	10.4	4	38.46	42×10^{-5}	1.5×10^{-4}	0.042	6.16	0.28	0.35	0.145	1.0
5	9.5	4	42.10	11×10^{-5}	1.1×10^{-4}	0.033	5.54	0.30	0.25	0.113	0.93

Table 4.5: Induced Draft Cooling Tower with Ink (250ml/110L)

Observation	Cooling Range + Approach, R_{th} (°C)	Cooling Range, R_a (°C)	Cooling efficiency η %	Change in sp. Humidity, Δw (kg/kg)	Make up water (m ³ /hr)	% make up water	Change in Heat Content Water, Q_1 (kJ/kg)	Change in Heat Content Air, Q_2 (kJ/kg)	Evaporation Loss, Q_3 (kJ/kg)	NTU	L/G
1	21.8	10	45.87	1.2×10^{-3}	1.25×10^{-3}	0.241	19.57	3.54	2.55	0.107	0.494
2	18.2	8	43.95	7×10^{-4}	656.6×10^{-6}	0.151	14.55	2.1105	1.48	0.117	0.455
3	16.1	8	49.63	1.5×10^{-3}	1.99×10^{-3}	0.362	13.44	4.15	3.27	0.162	0.423
4	12.4	7	56.45	1.7×10^{-3}	1.6×10^{-3}	0.438	10.79	4.62	3.65	0.219	0.388
5	12	8	66.67	1×10^{-3}	9.37×10^{-4}	0.235	11.18	0.7121	2.12	0.344	0.359

Table 4.6: Natural Draft Cooling Tower with Ink (250ml/110L) (Collected from other group)

Observation	Cooling Range + Approach, R_{th} (°C)	Cooling Range, R_a (°C)	Cooling efficiency η %	Change in sp. Humidity, Δw (kg/kg)	Make up water (m ³ /hr)	% make up water	Change in Heat Content Water, Q_1 (kJ/kg)	Change in Heat Content Air, Q_2 (kJ/kg)	Evaporation Loss, Q_3 (kJ/kg)	NTU	L/G
1	21.6	5	23.14	7×10^{-4}	2.5×10^{-4}	0.054	9.78	0.548	0.572	0.055	1.28
2	18.1	5	27.62	6×10^{-4}	2.166×10^{-4}	0.05	9.093	0.534	0.491	0.073	1.18
3	14.9	5	33.56	1.35×10^{-3}	4.91×10^{-4}	0.122	8.4	1.41	1.15	0.098	1.1
4	12.2	5	41	5×10^{-4}	1.8×10^{-4}	0.049	7.70	0.447	0.413	0.164	1.0
5	10.5	5	47.61	1.9×10^{-3}	6.854×10^{-4}	0.205	6.993	1.843	1.555	0.186	0.93

Table 4.7: Induced Draft Cooling Tower with Ink (200ml/110L)

Observation	Cooling Range + Approach, R_{th} (°C)	Cooling Range, R_a (°C)	Cooling efficiency η %	Change in sp. Humidity, Δw (kg/kg)	Make up water (m ³ /hr)	% make up water	Change in Heat Content Water, Q_1 (kJ/kg)	Change in Heat Content Air, Q_2 (kJ/kg)	Evaporation Loss, Q_3 (kJ/kg)	NTU	L/G
1	28.4	6	21.13	1.2×10^{-3}	1.14×10^{-3}	.243	11.76	3.03	2.57	0.051	0.494
2	23.7	6	25.32	1.4×10^{-3}	1.3248×10^{-3}	.389	8.56	4.17	3	0.074	0.455
3	17.3	7	40.46	2×10^{-4}	1.89×10^{-4}	.473	11.76	0.74	0.42	0.156	0.423
4	18.3	8	43.71	1×10^{-3}	9.46×10^{-4}	.258	12.3	2.63	2.14	0.153	0.388
5	17.7	8	45.2	9.3×10^{-4}	8.8×10^{-4}	.266	11.08	2.62	1.99	0.016	0.359

Table 4.8: Natural Draft Cooling Tower with Ink (200ml/110L) (Collected from other group)

Observation	Cooling Range + Approach,	Cooling Range, R_a (°C)	Cooling efficiency	Change in sp. Humidity, Δw (kg/kg)	Make up water (m ³ /hr)	% make up water	Change in Heat Content Water, Q_1 (kJ/kg)	Change in Heat Content Air, Q_2 (kJ/kg)	Evaporation Loss, Q_3 (kJ/kg)	NTU	L/G
1	28.6	4	13.98	1.5×10^{-3}	5.46×10^{-4}	1.17×10^{-3}	7.8456	1.7472	1.24	.034	1.28
2	22.5	4	17.78	1×10^{-3}	3.607×10^{-4}	88×10^{-3}	7.224	1.054	0.818	.052	1.18
3	20	4	20	3×10^{-4}	1.09×10^{-4}	2.73×10^{-4}	6.72	0.2878	0.248	.078	1.1
4	18.2	4	22	2.2×10^{-3}	8.0×10^{-4}	2.186×10^{-1}	6.148	2.386	1.815	.078	1.0
5	18	5	27.7	1.06×10^{-3}	3.857×10^{-4}	116.8×10^{-3}	6.93	3.537	0.875	.103	0.93

Table 4.9: Induced Draft Cooling Tower with Ink (150ml/110L)

Observation	Cooling Range + Approach, R_{th}	Cooling Range, R_a (°C)	Cooling efficiency	Change in sp. Humidity, Δw (kg/kg)	Make up water (m ³ /hr)	% make up water	Change in Heat Content Water, Q_1 (kJ/kg)	Change in Heat Content Air, Q_2 (kJ/kg)	Evaporation Loss, Q_3 (kJ/kg)	NTU	L/G
1	24.4	7	28.69	1.4×10^{-3}	1.324×10^{-3}	0.284	13.729	3.765	3	0.078	0.494
2	20.6	6	29.13	1.2×10^{-3}	1.135×10^{-3}	0.264	10.837	3.103	2.62	0.098	0.455
3	19.9	6	30.93	1.1×10^{-3}	1.041×10^{-3}	0.2601	10.08	3.1	2.36	0.106	0.423
4	17.7	7	39.55	1.5×10^{-3}	1.419×10^{-3}	0.3866	10.789	4.22	3.22	0.152	0.388
5	14.5	8	55.17	1.7×10^{-3}	1.61×10^{-3}	0.473	11.424	4.62	3.65	0.251	0.359

Table 4.10: Natural Draft Cooling Tower with Ink (150ml/110L) (Collected from other group)

Observation	Cooling Range +	Cooling Range, R_a (°C)	Cooling efficiency	Change in sp. Humidity, Δw (kg/kg)	Make up water (m ³ /hr)	% make up water	Change in Heat Content Water, Q_1	Change in Heat Content Air, Q_2	Evaporation Loss, Q_3 (kJ/kg)	NTU	L/G
1	24.4	3	12.29	4×10^{-4}	1.546×10^{-4}	0.0312	5.88	0.4332	0.33	0.034	1.28
2	21.1	5	23.7	5×10^{-4}	1.82×10^{-4}	0.0423	9.03	0.5787	0.392	0.080	1.18
3	19.6	4	20.41	7×10^{-4}	2.548×10^{-4}	0.0637	6.72	.74	0.578	0.069	1.1
4	17.7	5	28.25	5×10^{-4}	1.82×10^{-4}	0.0496	7.71	.5752	0.413	0.106	1.0
5	14.6	5	34.25	8×10^{-4}	2.912×10^{-4}	0.0856	7.14	.881	0.661	0.158	0.93

Chapter Five

Result & Discussion

5.1 Cooling Tower Characteristics Analysis:

In this experiment we have determined tower characteristics at varying air and water flow rate ratio. The NTU or tower characteristics was determined by using equation (4). Enthalpy of saturated air at hot water temperature was determined by using saturated air properties table. Enthalpy of air stream was calculated from psychometric chart. Using equation (1) cooling efficiency was determined.

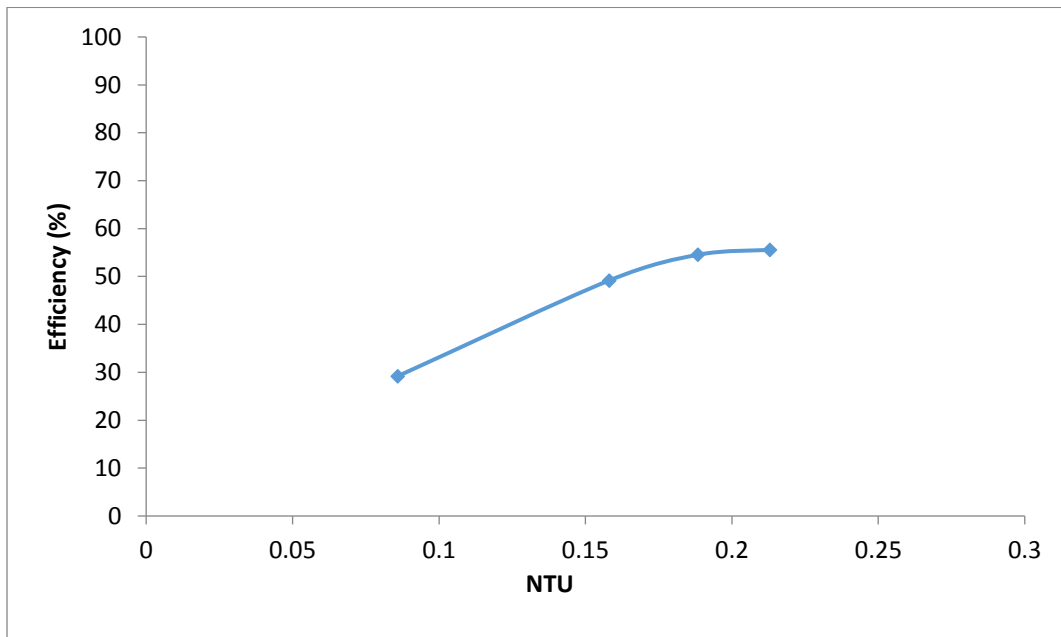

Figure 5.1: Efficiency vs NTU

In This Graph a relation between Efficiency and NTU of induced draft cooling tower has been established corresponding to the data shown in Appendix [A11].

In figure (5.1) we can explicitly see a direct relation between tower characteristics and tower efficiency. With tower characteristics increase the latent heat and sensible heat transfer is also increased so the efficiency is also increased.

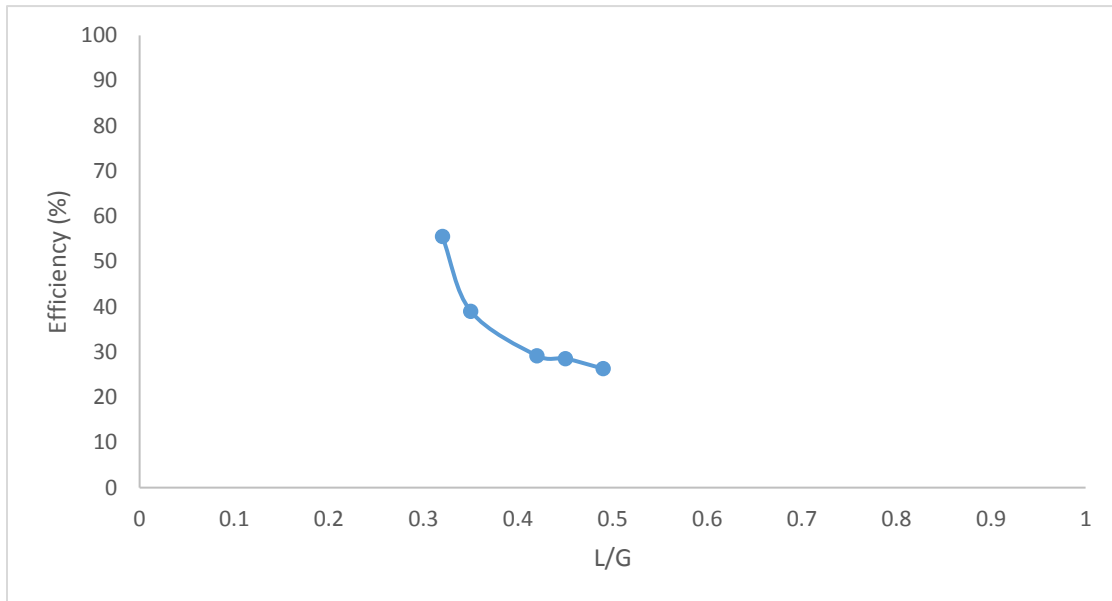

Figure 5.2: Efficiency vs L/G

In This Graph a relation between Efficiency and L/G of induced draft cooling tower has been established corresponding to the data shown in Appendix [A9].

From figure (5.2) as the $\frac{L}{G}$ ratio increase the tower efficiency decrease. This is because with $\frac{L}{G}$ increase hot water flow rate increase and with unabundant present air flow to cool it. In figure (5.1) and (5.2) error bars is their due to inherent error is anemometer in air speed reading and human error in taking dry bulb and wet bulb temperature from psychrometer.

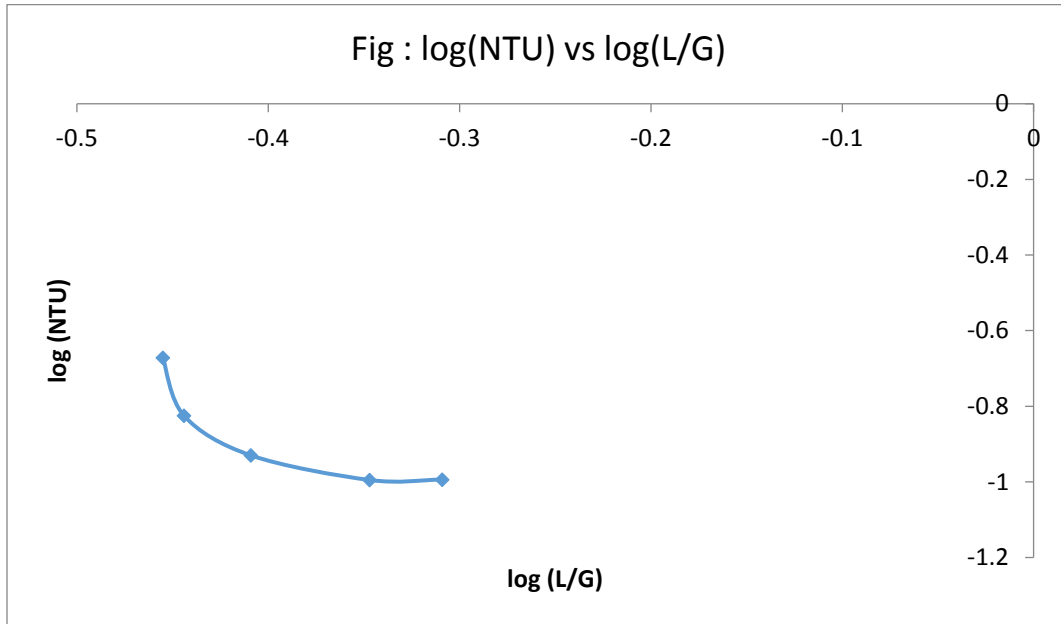

Figure 5.3: log NTU vs log L/G

In This Graph a relation between log NTU vs log L/G of induced draft cooling tower has been established corresponding to the data shown in Appendix [A10].

The figure (5.3) we can see there is exponential relation between $(\frac{L}{G})$ and NTU. $NTU \propto (\frac{L}{G})^n$ where n is the coefficient the available coefficient of cooling tower is defined as the point on a required coefficient curve at which a cooling tower will operate for specific operating condition. [14]. for calculating coefficient NTU and $\frac{L}{G}$ is plotted in logarithmic scale and conducting a linear fit data. As we can see in figure (5.3) we conducted a linear fit in ftool of matlab package to equation (3) and n coefficient was calculated as (4). The value doesn't lie with in average value.

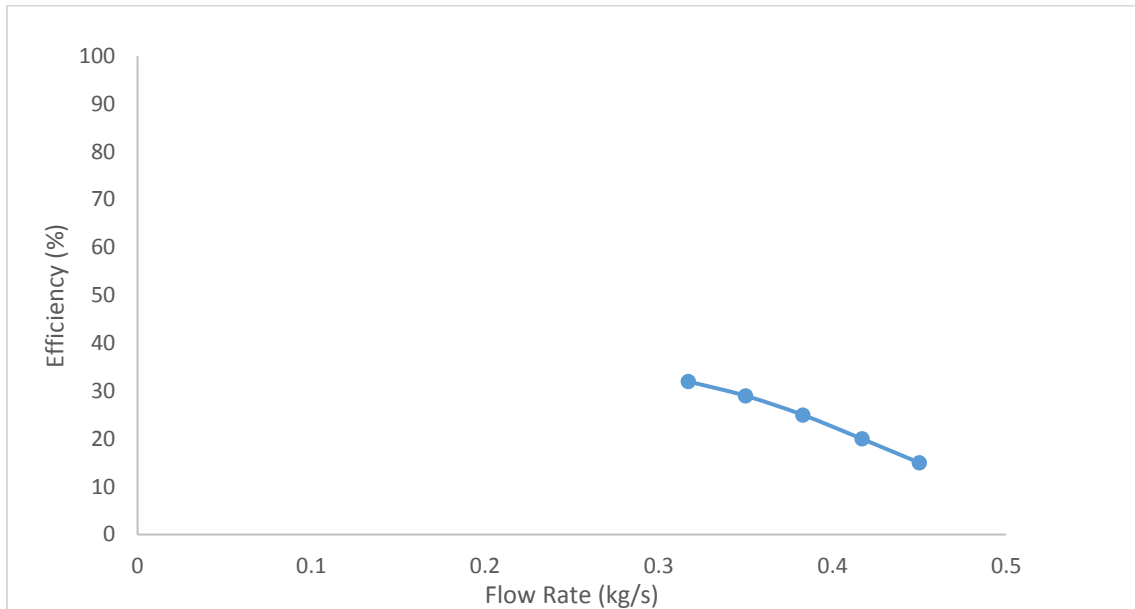

Figure 5.4: Efficiency vs Flow Rate at Constant Inlet Temp. 38 ° C

In This Graph a relation between Efficiency and Flow Rate at Constant Inlet Temperature of induced draft cooling tower has been established in case of induced draft corresponding to the data shown in Appendix [A12]

From the above figure we can see that with the decrease of flow rate efficiency increases.

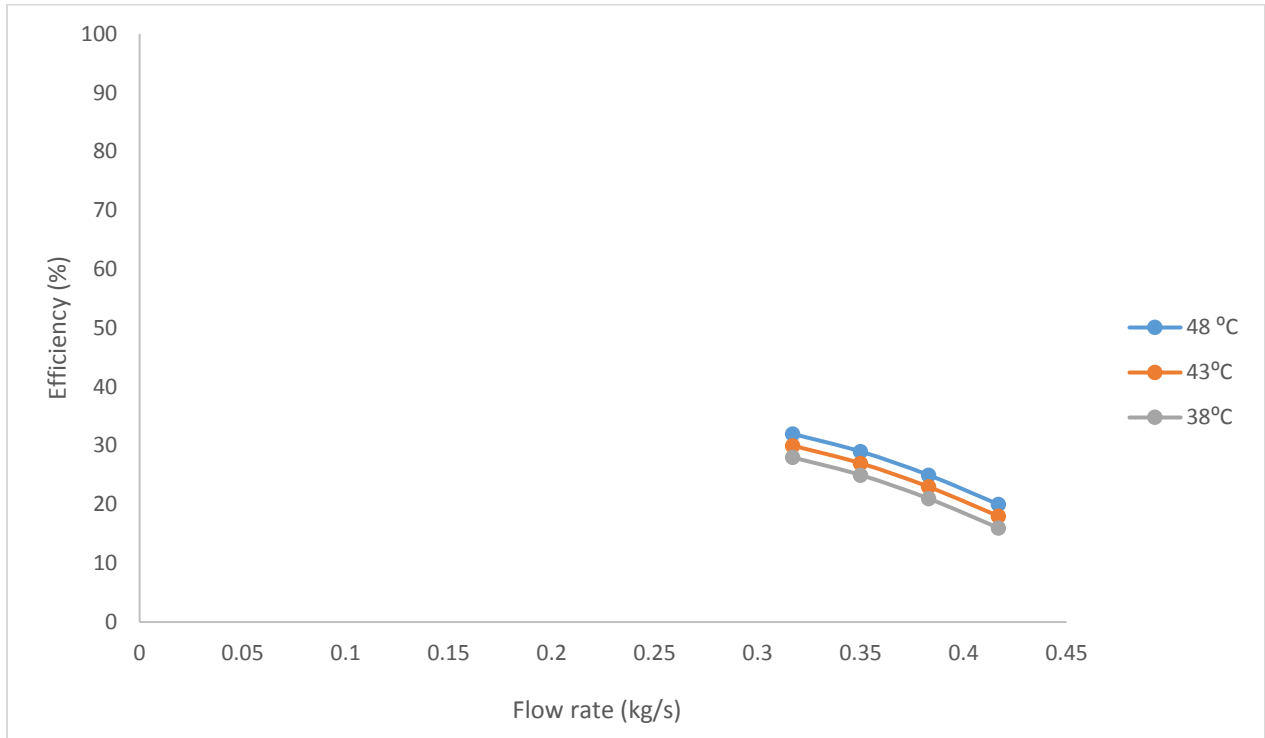

Figure 5.5: Efficiency vs Flow Rate at different Inlet Temp.

In This Graph a relation between Efficiency and Flow Rate at different Inlet Temperature of induced draft cooling tower has been established corresponding to the data shown in Appendix [A13].

In this figure we can see that the efficiency of the cooling tower at different inlet temperature with the decrease of water inlet temperature efficiency also decreases.

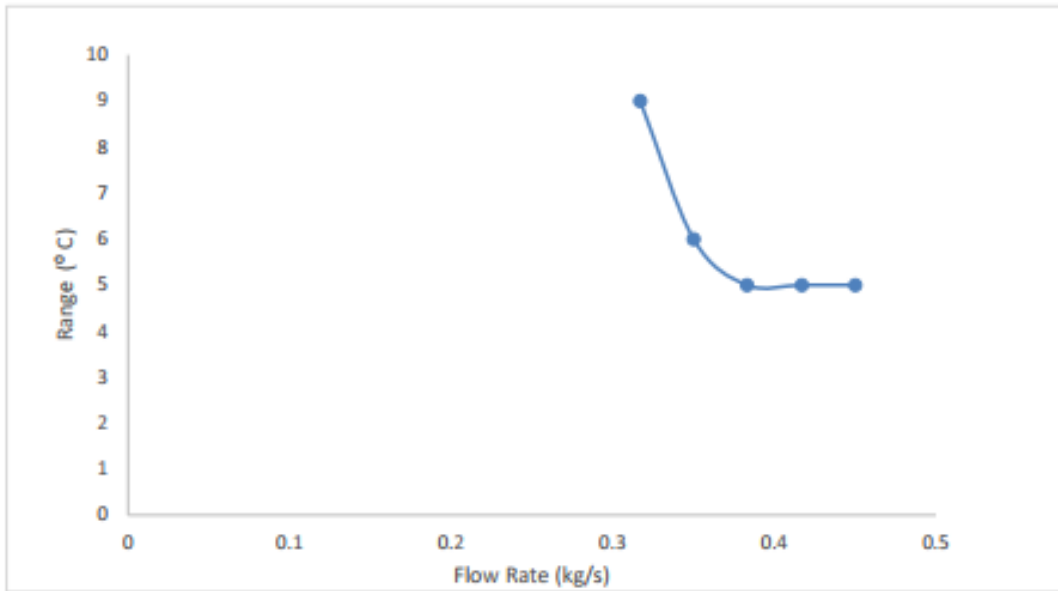
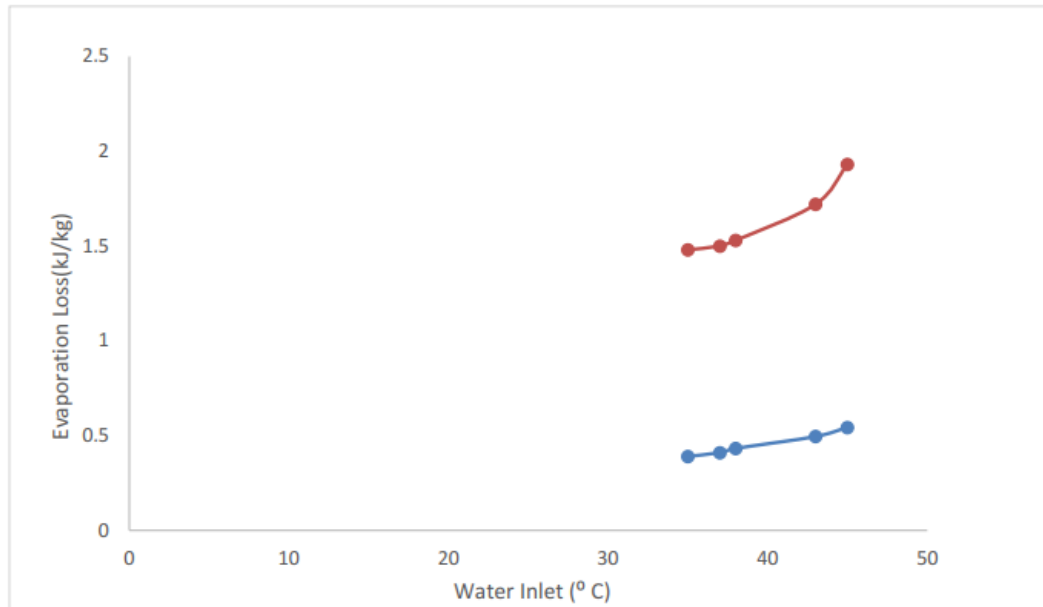

Figure 5.6: Range vs Flow Rate

In This Graph a relation between Flow Rate and Range at 38 ° C Inlet Temperature of induced draft cooling tower has been established corresponding to the data shown in Appendix [A20].

In this graph we can observe that with the increase of flow rate, range decreases.

5.2 Comparative Study of Performance of Induced & Natural Draft Cooling Tower:



**Figure 5.7: Evaporation Loss vs Water Inlet for Natural & Induced Draft Cooling Tower
(At Constant Flow Rate)**

In This Graph a relation between evaporation loss & water inlet temperature of natural and induced draft cooling tower has been established corresponding to the data shown in Appendix [A8].

On the graph it has been seen that heat loss by evaporation of water in case of induced draft is much higher than natural draft.

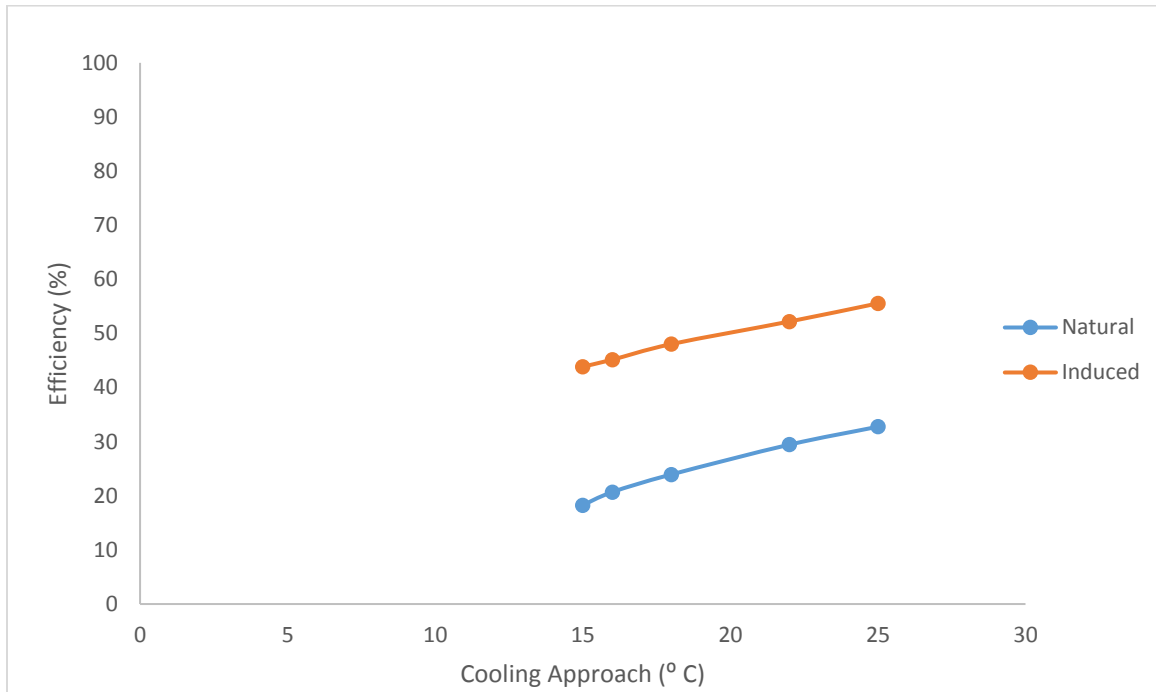

Figure 5.8: Efficiency vs Approach (At same Flow Rate)

In This Graph a relation between Efficiency & Approach of natural and induced draft cooling tower has been established corresponding to the data shown in Appendix [A4].

On the graph it has been seen that with the approach increasing, efficiency also increases and we can also see that efficiency vs approach curve of induced draft is at much more higher position than natural draft.

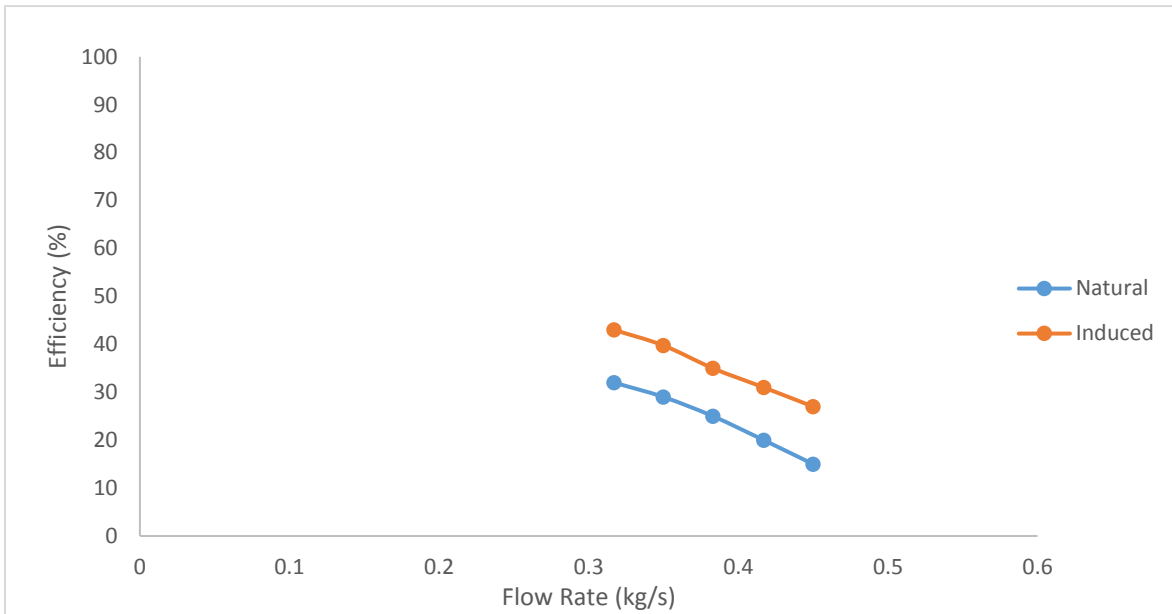

Figure 5.9: Efficiency vs Flow Rate (At same inlet temp.)

In This Graph a relation between Efficiency & Flow Rate of natural and induced draft cooling tower has been established corresponding to the data shown in Appendix [A6].

In this graph we can observe at constant inlet temperature but for different flow rate, with the increases of flow rate, efficiency decreases and we can also see that flow rate vs efficiency curve of induced draft is at much higher position than natural draft.

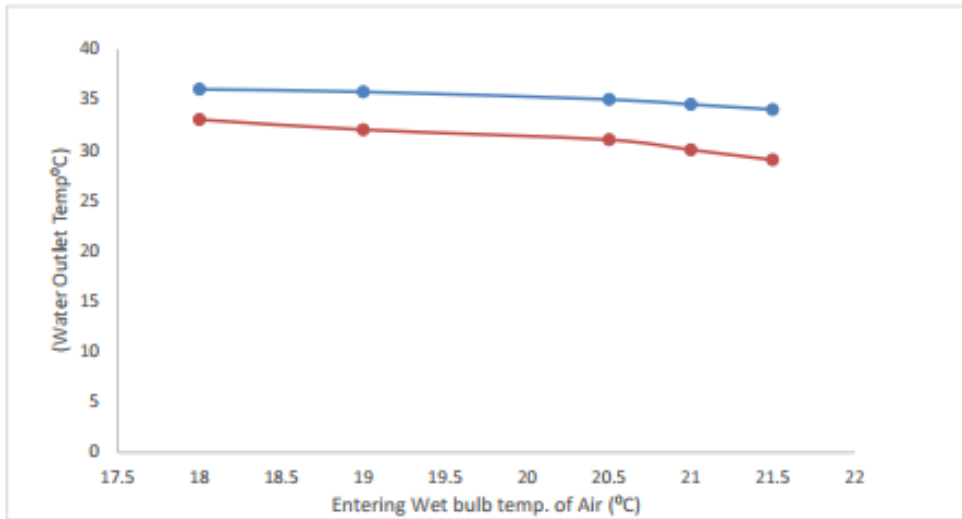

Figure 5.10: Water outlet Temp. vs Entering Wet Bulb Temperature of Air

In This Graph a relation between Entering Wet Bulb Temperature of Air and Water out Temperature natural and induced draft cooling tower has been established corresponding to the data shown in Appendix [A5].

In this graph we can see that efficiency of induced draft cooling tower is higher than natural draft cooling tower.

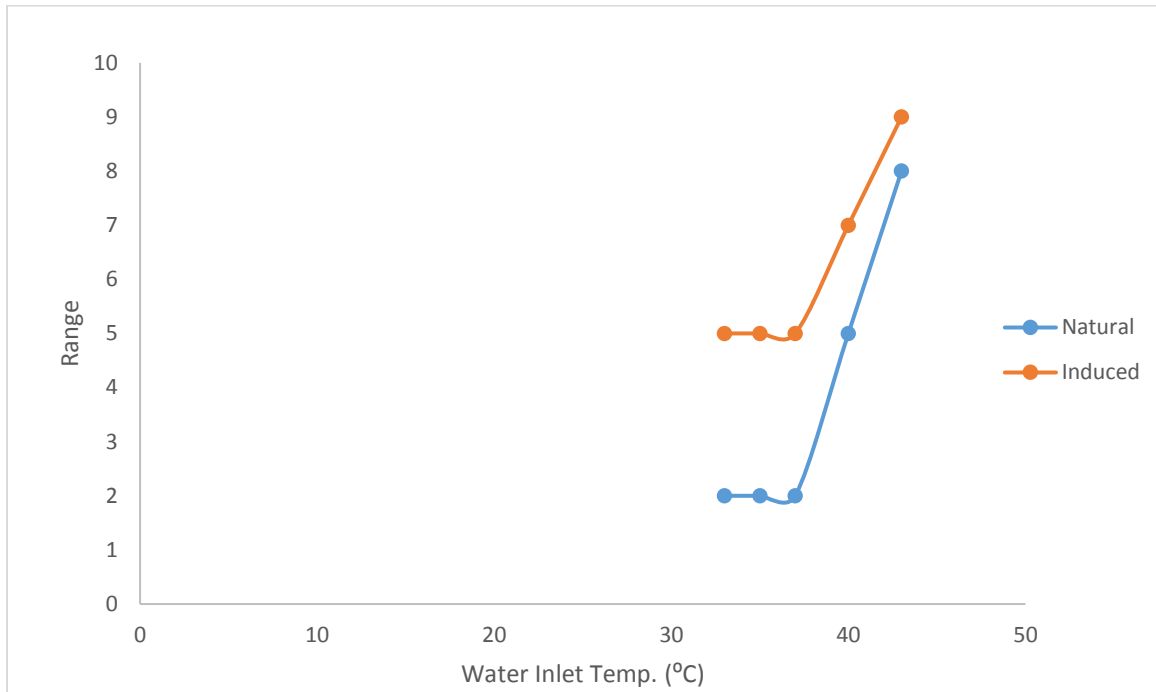

Figure 5.11: Range vs Water Inlet at same Flow Rate

In This Graph a relation between Water Inlet and Range at same Flow Rate of natural and induced draft cooling tower has been established corresponding to the data shown in Appendix [A7].

We can see that with the increases of water inlet temperature range also increases. And we can also see that water inlet Temp. vs range curve of induced draft is at much more higher position than natural draft.

5.3 Effect of Ambient Humidity on Cooling Tower Performance:

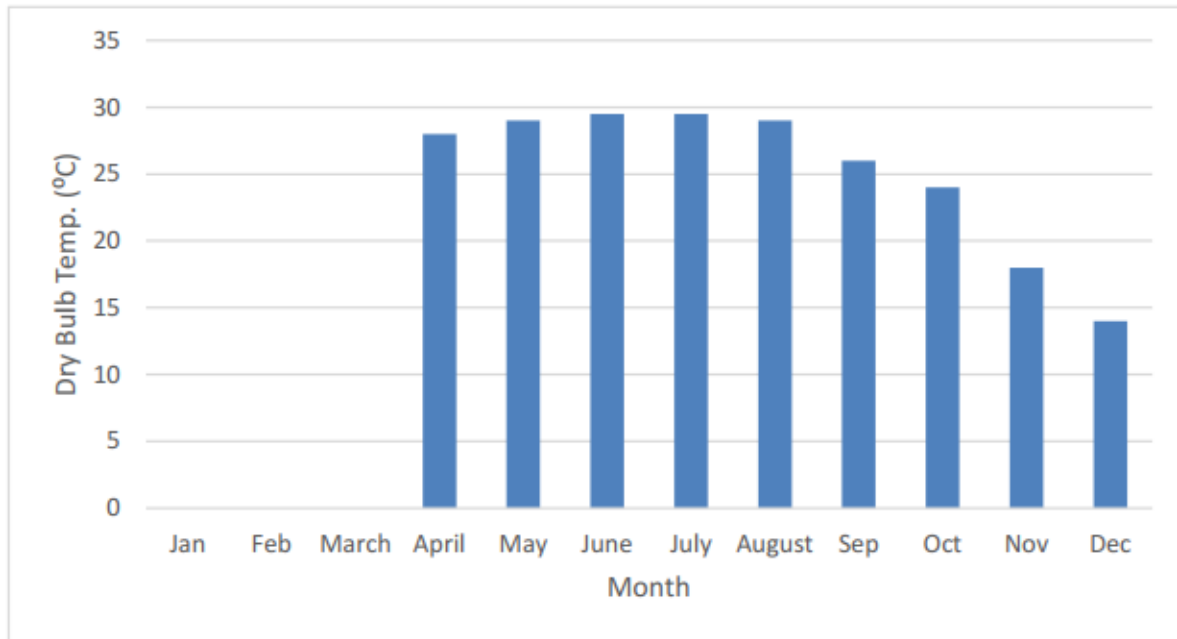

Figure 5.12: Dry Bulb Temperature vs Month

In this figure the average dry bulb temperature of experimental site at different month of the year has been shown corresponding to the data shown in Appendix [A14].

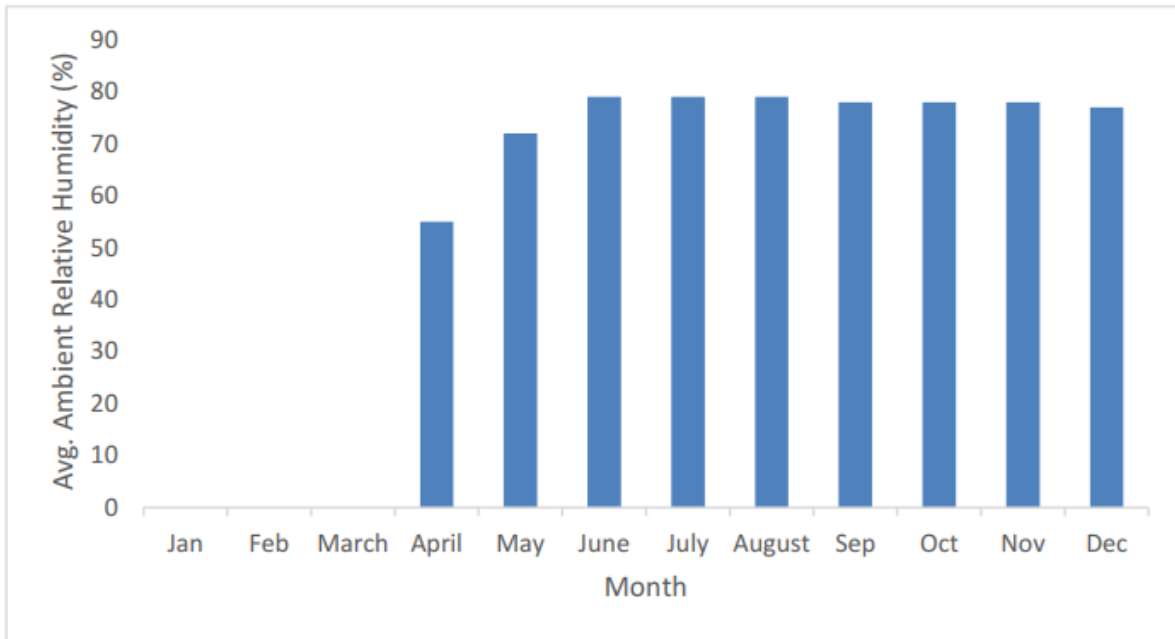

Figure 5.13: Avg. Ambient Relative Humidity vs Month

In this figure the average humidity of experimental site at different month of the year has been shown corresponding to the data shown in Appendix [A3].

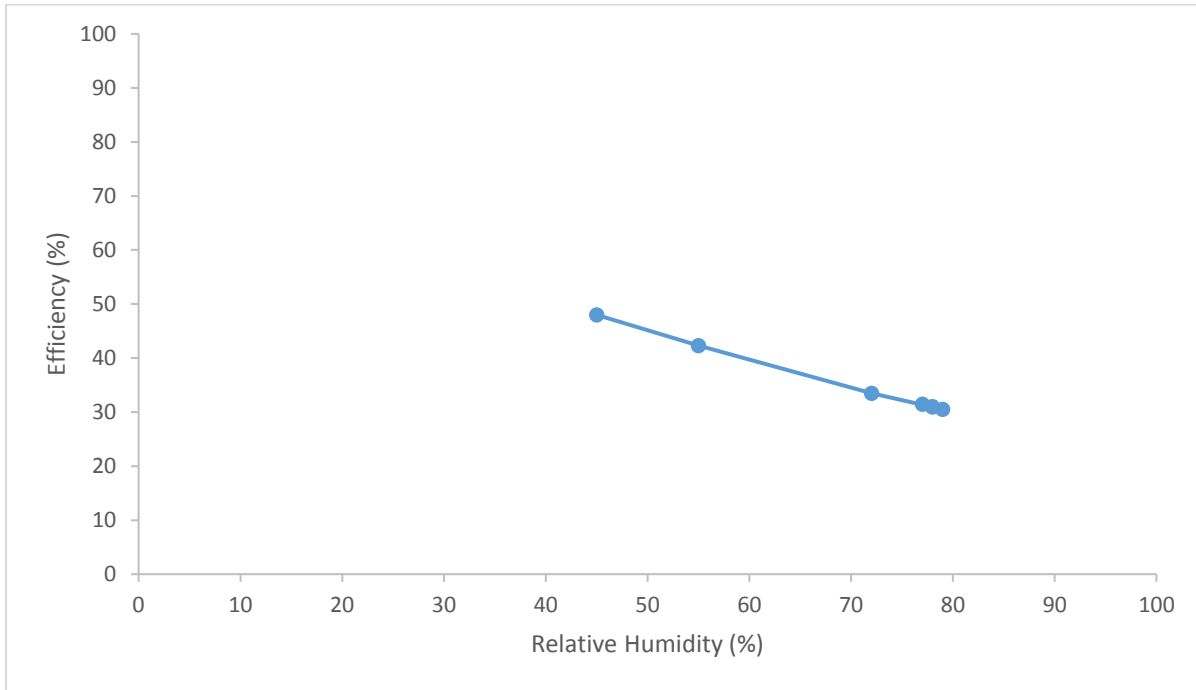

Figure 5.14: Efficiency vs Relative Humidity

In This Graph a relation between Efficiency and Relative Humidity of induced draft cooling tower has been established in case of induced draft corresponding to the data shown in Appendix [A15].

From the above figure it has been observed that efficiency of the cooling tower decreases. This is because with the increases of humidity capacity of the air to absorb water decreases.

5.4 Comparison of Cooling Tower Performance with Cooling Fluid of Various Qualities:

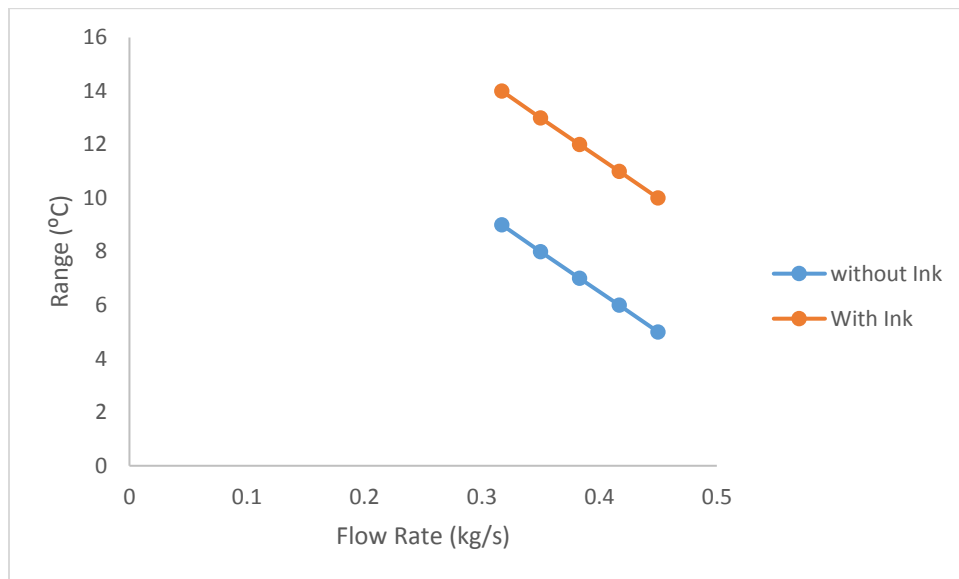

Figure 5.15: Range vs Flow Rate of Induced Draft

In This Graph a relation between Range and Flow Rate of induced draft cooling tower at 38 ° C inlet temperature and with cooling fluid of ink water ratio 100ml/110 L has been established in case of induced draft corresponding to the data shown in Appendix [A 19].

From the above figure it has been observed that range increases due to the addition of ink. The value in average is 9 ° C in case of induced draft cooling tower whereas without ink it is 5 ° C.

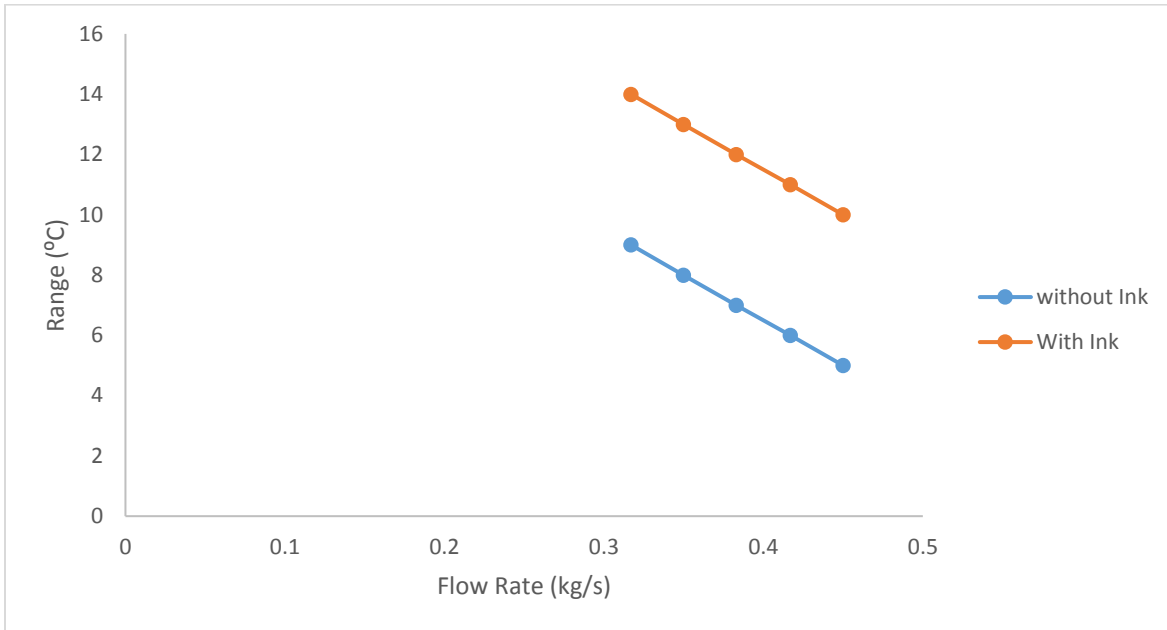

Figure 5.16: Range vs Flow Rate of Natural Draft

In This Graph a relation between Flow Rate and Range of natural draft cooling tower at 38 ° C inlet temperature and with cooling fluid of ink water ratio 100ml/110 L has been established in case of natural draft corresponding to the data shown in Appendix [A].

From the above figure it has been observed that range increases due to the addition of ink. The value in average is 5 ° C in case of natural draft cooling tower whereas without ink it is 2 ° C.

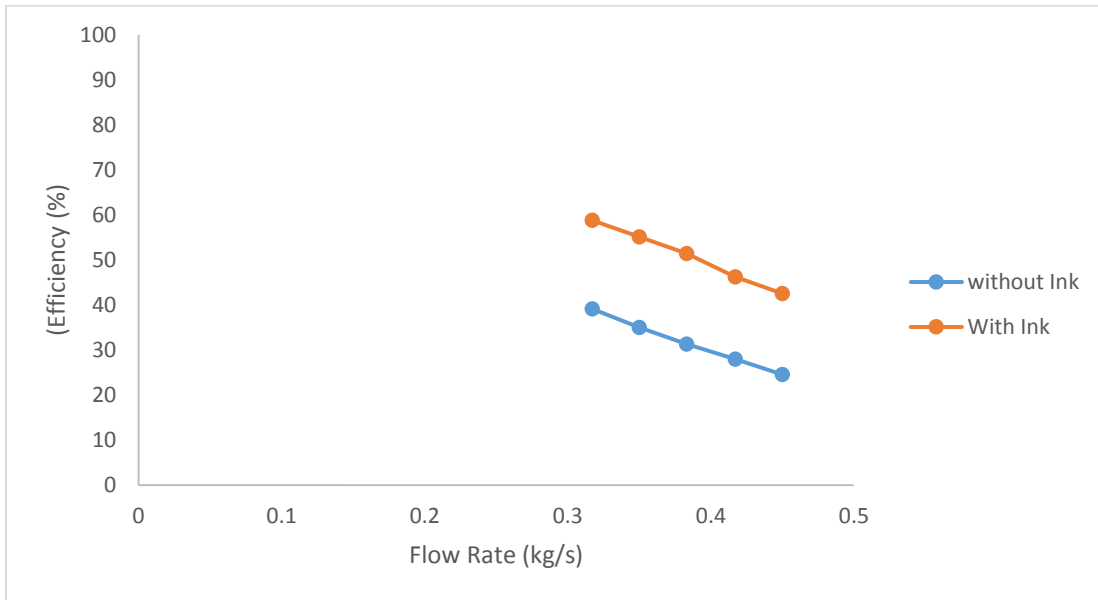

Figure 5.17: Efficiency vs Flow Rate of Induced Draft

In This Graph a relation between Flow Rate and Efficiency of induced draft cooling tower at 38 ° C inlet temperature and with cooling fluid of ink water ratio 100ml/110 L has been established in case of induced draft corresponding to the data shown in Appendix [A 22].

From the above figure it has been observed that efficiency increases due to addition of ink. The values of Efficiency vary from 28.5 % to 39.15 % in case of induced draft cooling tower with water whereas with ink it is 42.55 % to 58.42 %.

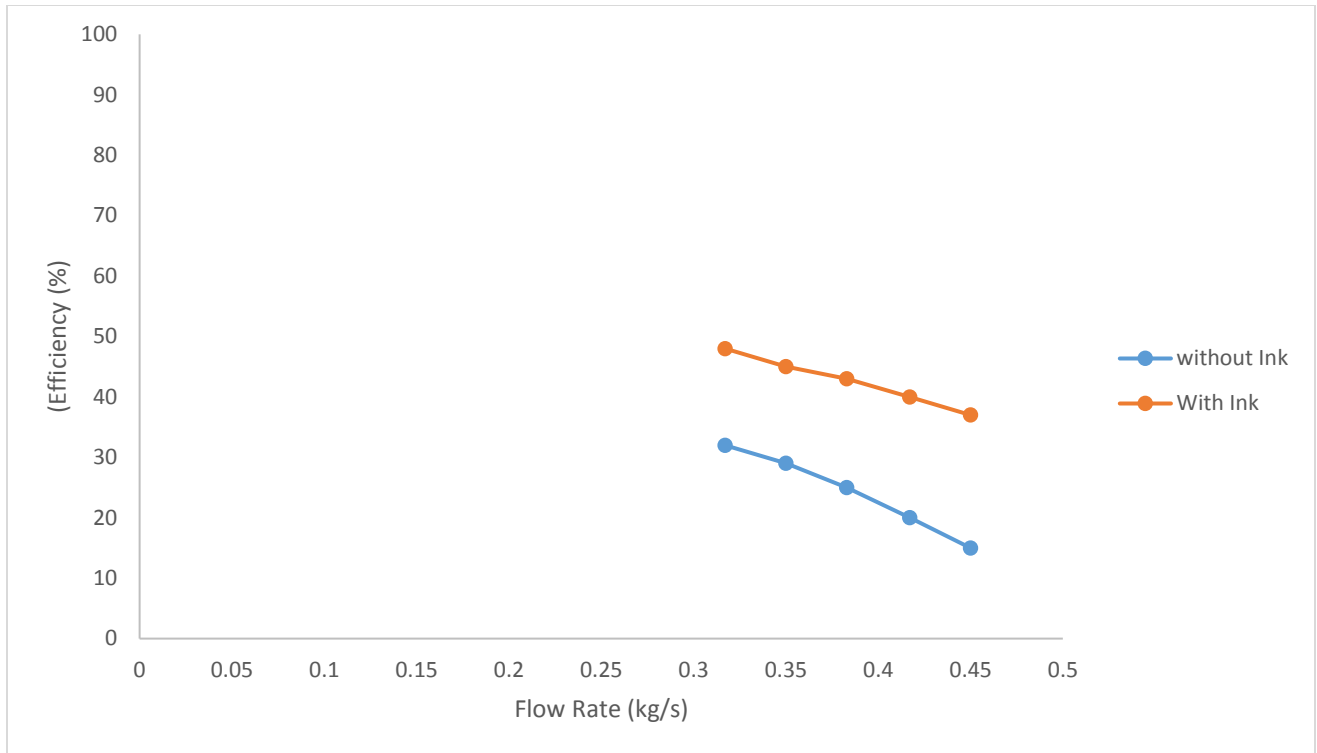

Figure 5.18: Efficiency vs Flow Rate of Natural Draft

In This Graph a relation between Flow Rate and Efficiency of natural draft cooling tower at 38 ° C inlet temperature and with cooling fluid of ink water ratio 100ml/110 L has been established in case of natural draft corresponding to the data shown in Appendix [A 21].

From the above figure it has been observed that efficiency increases due to the addition of ink. The value of Efficiency vary from 15% to 32 % in case of natural draft cooling tower with normal water whereas with ink it is 39.72 % to 48.54 %.

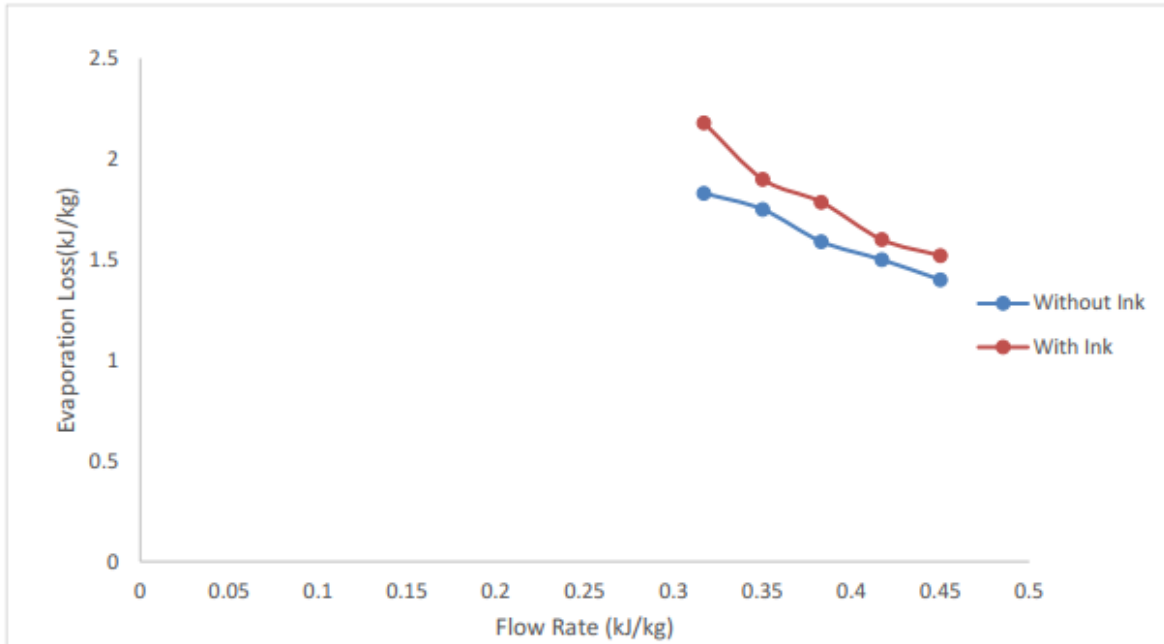

Figure 5.19: Evaporation Loss vs Flow Rate of Induced Draft

In This Graph a relation between Flow Rate and Evaporation Loss of induced draft cooling tower at 38 ° C inlet temperature and with cooling fluid of ink water ratio 100ml/110 L has been established in case of induced draft corresponding to the data shown in Appendix [A 17].

From the above figure it has been observed that evaporation loss increases due to the addition of ink. The values of evaporation loss vary from 1.83 to 1.40 kJ/kg in case of induced draft cooling tower with normal water whereas with ink it is 2.18 to 1.52 kJ/kg.

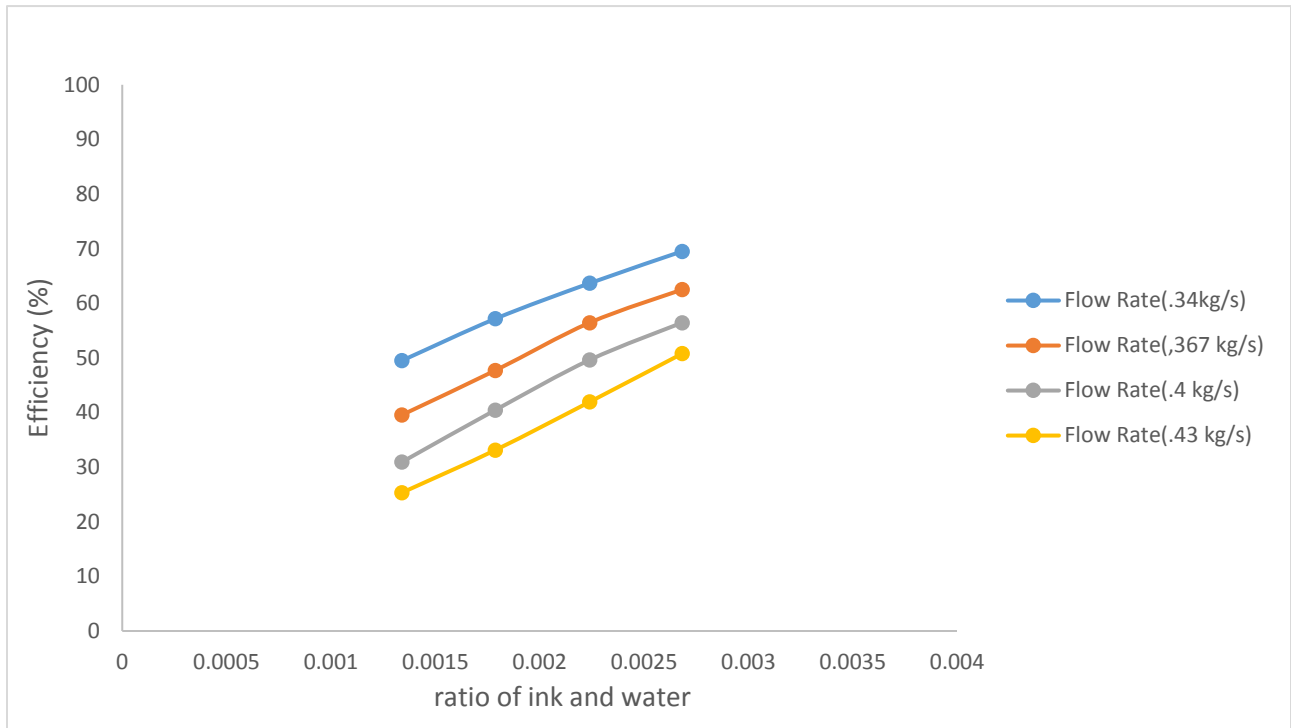

Figure 5.20: Efficiency vs Ratio of ink water

In This Graph a relation between Efficiency and Ratio of ink water of induced draft cooling tower has been established in case of induced draft corresponding to the data shown in Appendix [A 23].

We can see that with the increases of ratio of ink and water efficiency also increases and also we can see that the curve of lower flow rate is at higher position.

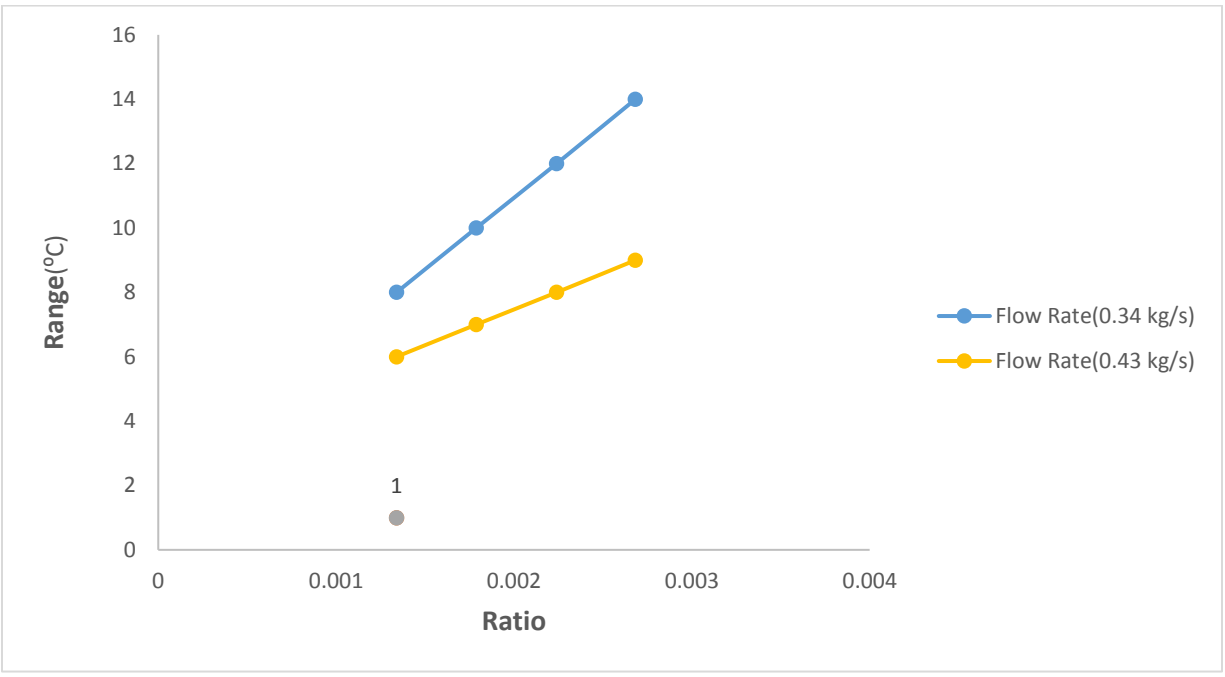

Figure 5.21: Range vs Ratio

In This Graph a relation between **Range and Ratio** of induced draft cooling tower has been established in case of induced draft corresponding to the data shown in Appendix [A 24].

In this graph it has been observe that the increases of ratio, range increases. And with the decreases of flow rate range increases.

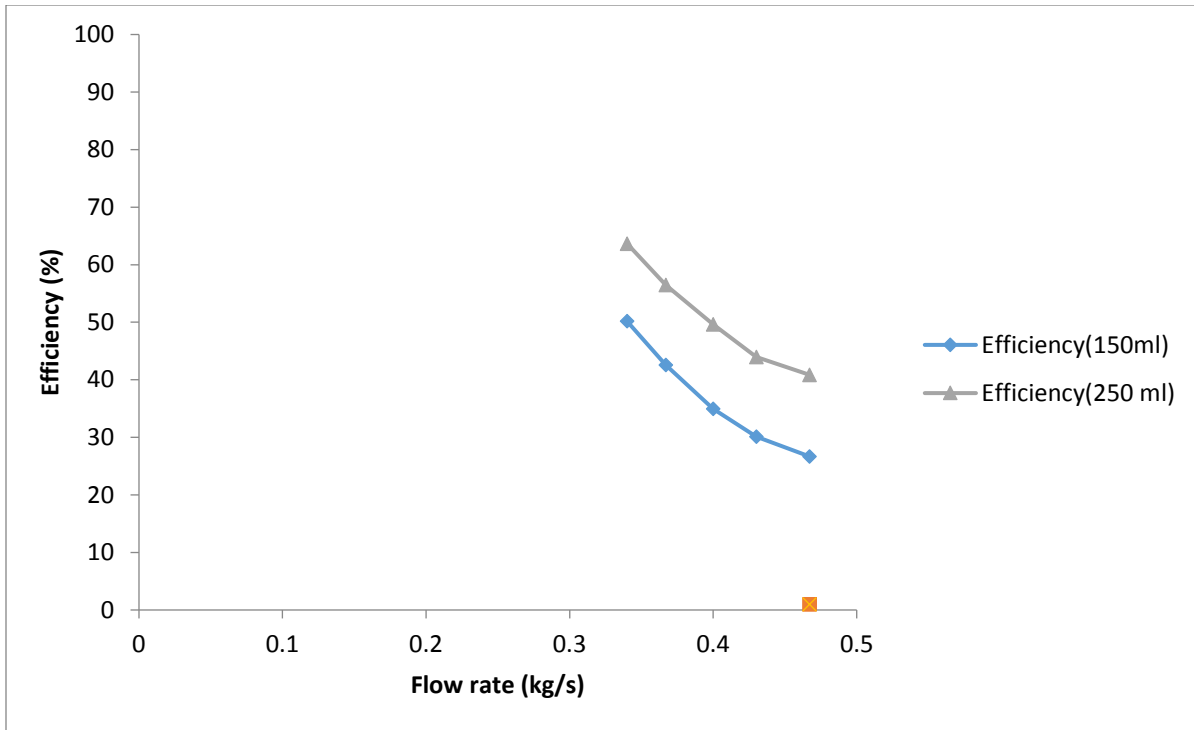

Figure 5.22: Efficiency vs Flow Rate

In This Graph a relation between **Efficiency and Flow Rate** of induced draft cooling tower has been established in case of induced draft corresponding to the data shown in Appendix [A 33].

From the graphical presentation it is seen that with the increase of flow rate the efficiency decreases.

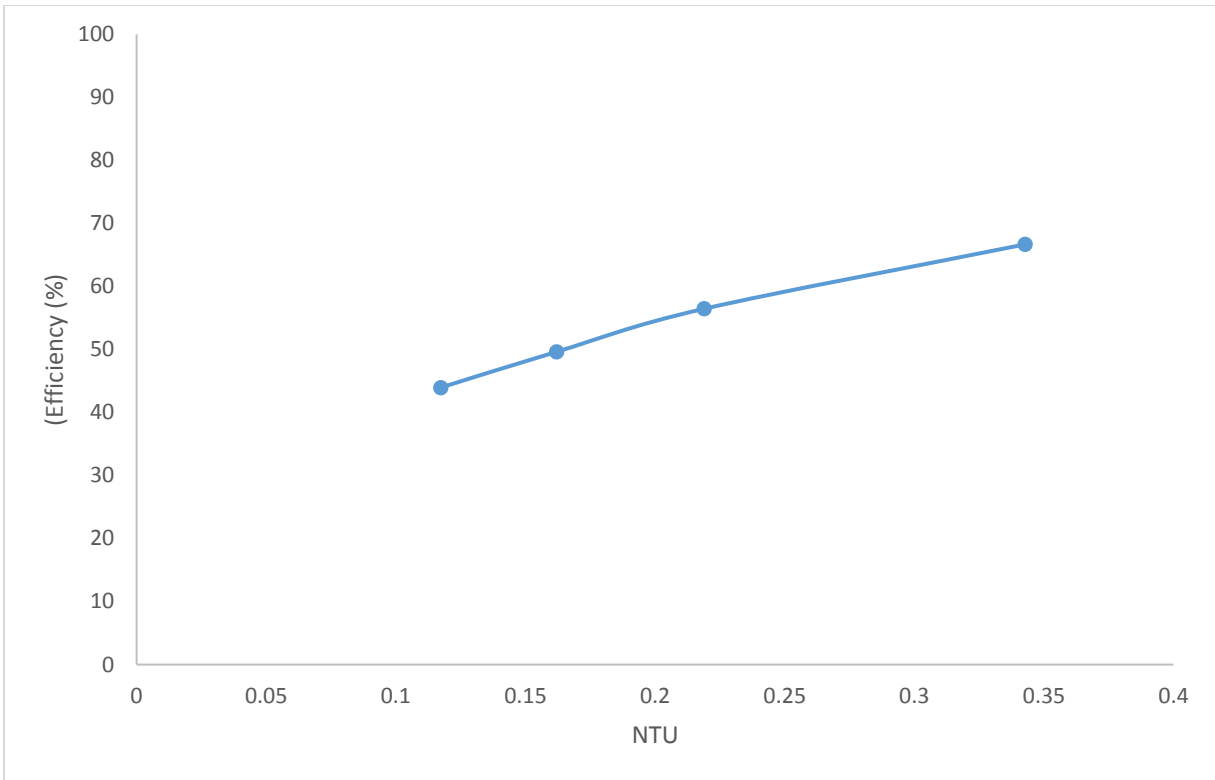

Figure 5.23: Efficiency vs NTU

In This Graph a relation between **Efficiency and NTU** of induced draft cooling tower has been established in case of induced draft corresponding to the data shown in Appendix [A 34].

From the graph it is seen that with the increase of NTU the efficiency of the cooling tower is increased.

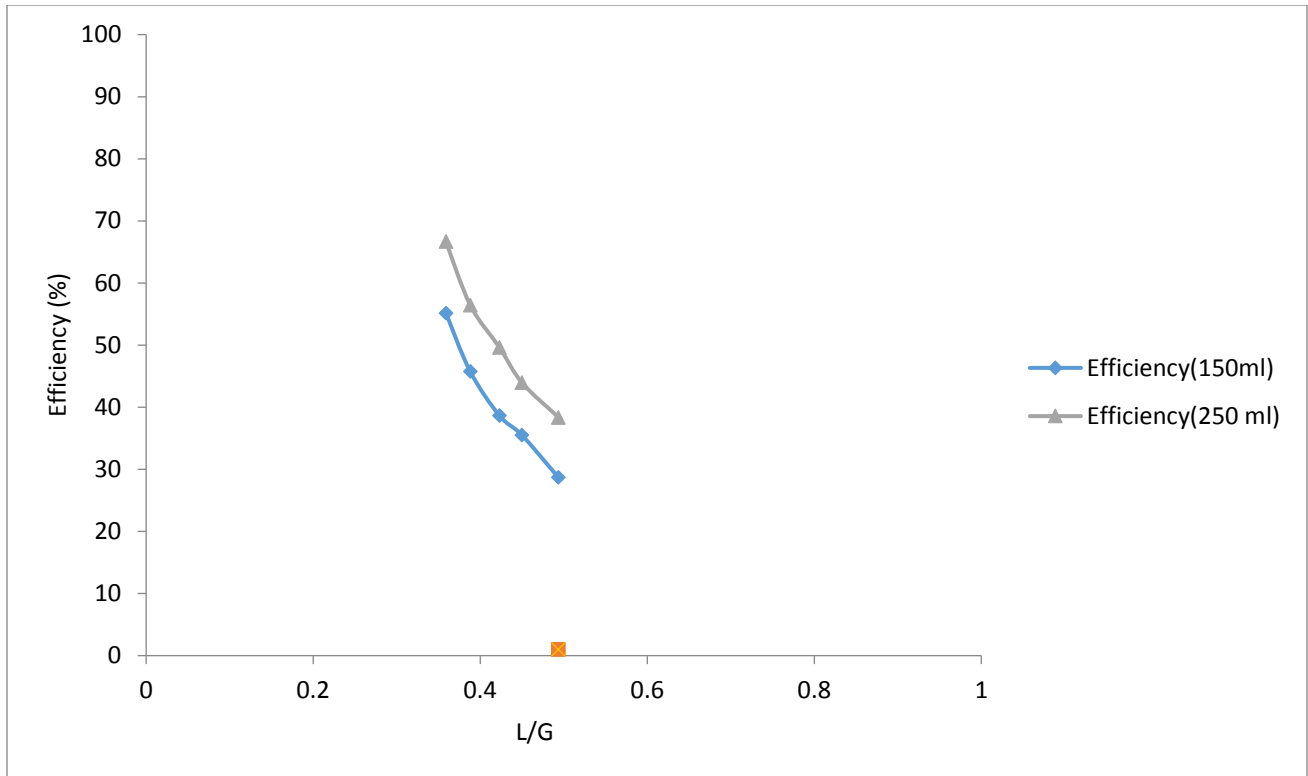

Figure 5.24: Efficiency vs L/G

In This Graph a relation between **Efficiency and L/G** of induced draft cooling tower has been established in case of induced draft corresponding to the data shown in Appendix [A 35].

From the graphical representation above it is seen that with the increase of water and air flow rate ratio the efficiency is decreased

Chapter Six

Conclusion

6.1 Conclusion

The tower characteristics, efficiency, make up water and heat loss due to evaporation of natural and induced draft cooling with different quality of circulating fluids were evaluated. It was found that when L/G increases it was observed that both efficiency and cooling tower characteristics increase. So we can see with decrease of flow rate efficiency and cooling tower characteristics decreases. It was found that with the increase of humidity, cooling tower efficiency decrease. It was found that due to addition of toner with water the efficiency, range, evaporation heat loss increases. For induced draft efficiency and range increase by 8% & 4°C in average respectively and for natural draft range efficiency and range increase by 5% & 2° respectively. With the increase of percentage of toner in water it was observed that efficiency and range increase which has been shown graphically.

6.2 Limitations

- Heat source we designed is not controllable and is time consuming.
- We did not calculate the heat content variation due to friction in pipe.
- Flow meter we used have limitation of maximum value upto 30 L/m.
- No drift eliminator was used.
- Heat loss due to conduction convection drift and windage was not calculated.
- Sensor we used was able to sense air dry bulb temperature and humidity. Then we had to go to psychometric chart to find wet bulb temperature which have probability of having human error.
- Health hazard and environmental hazard of toner was not considered.
- The corrosion of pipe due to toner was not considered.

6.3 Recommendation

- In this experimental study the heat loss through the pipe & pump were not being considered. So in further studies these heat losses can be calculated for getting a better result.
- In this thesis work air mass flow rate was assumed as constant throughout. For further study air mass flow rate at each cell of cooling tower can be calculated.
- In our experimental studies, we could not make arrangement for varying the value of air mass flow. So in further approach, induced fan (ID fan) with varying speed capacity can be used. Thus cooling tower performance for varying air mass flow can be analyzed.
- The cooling water used in our experiment was natural supplied water which contains large fraction of iron. This iron was deposited on flow meter and flow meter accuracy was hampered. So, water treatment plant can be established.
- In our experimental studies we have used a mixture of water and toner. And toner has detrimental effect on environment. So further studies on how to reduce the environmental and health hazard can be done.
- Cost effectiveness of using toner can be studied further.
- A water temperature control system can be developed in further study.
- Heat source we used was combined of 2kw. So time taken to achieve the desire temperature was quite long. So by increasing heat source capability time taken can be reduced.

References:

- [1] Treatise on Heat Engineering by Dr. V. P. Vasandani & Dr. D. S. Kumar, fourth edition, page 2.1-3.17
- [2] Thermal Engineering by Er. R. K. Rajput, Ninth Edition, page from 874 to 875
- [3] Kamel Hooman, Hal Gurgenci, Zhiqiang Guan, Yuanshen Lu, Manuel Lucas, Cooling Tower and Heat Exchanger 2015, Proceedings of the 17 th IAHR International Conference.
- [4] <https://www.brooksinstrument.com/en/products/variable>
- [5] <http://www.thermometricscorp.com/thermocouple.html>
- [6] <https://www.thermocoupleinfo.com/>
- [7] https://www.electronicshub.org/humidity-sensor-types-working-principle/#Humidity_Sensors_Classification_and_Working_Principles
- [8] <https://learn.sparkfun.com/tutorials/what-is-an-arduino>
- [9] Creating a New Model to Predict Cooling Tower Performance and Determining Energy Saving Opportunities through Economizer Operation by Pranav Yedatore Venkatesh *University of Massachusetts - Amherst*, pranavyv@gmail.com
- [10] <http://www.power-eng.com/articles/print/volume-121/issue-7/features/cooling-tower-heat-transfer-fundamentals.html>
- [11] <https://classes.engineering.wustl.edu/che473/handouts/cooling%20tower%20performance.pdf>
- [12] **GopinathD, Gurumurthy, Akilan, Azhager, Manimaran , Prabhakaran** “Analysis on Performance of Natural Draught Cooling Tower” Journal of Chemical and Pharmaceutical Sciences ISSN: 0974-2115
- [13] <https://en.wikipedia.org/wiki/Toner>
- [14] Baker and H.A shyock, “Acomprehensive approach to analysis of cooling tower”

Appendix: A

Data Collection

A1: Data Table for Induced Draft:

Observation No	Inlet Air					Outlet Air					Water		
	Dry Bulb Temp.	Wet Bulb Temp.	Relative Humidity	Enthalpy	Specific Humidity	Dry Bulb Temp.	Wet Bulb Temp.	Relative Humidity	Enthalpy	Specific Humidity	Inlet Temp.	Outlet Temp.	Water Flow Rate
	° C	° C	%	kJ/kg	kg/kg	° C	° C	%	kJ/kg	kg/kg	° C	° C	kg/s
1	26	20.4	60	58.41	0.0126	26.5	21.3	63	61.59	0.0137	45	36	0.45
2	25.8	19.8	57	56.34	0.0119	26.3	20.6	60	59.09	0.0128	45	39	0.417
3	26.3	19.6	53.5	55.63	0.0114	25.8	19.8	57	56.34	0.0119	40	35	0.383
4	25.8	19.6	56	55.66	0.0116	25.9	20.3	60	58.06	0.0125	38	33	0.35
5	26	20.2	59	57.71	0.0123	26.3	21	62	60.51	0.0133	37	33	0.317

A2: Data Table for Natural Draft: (Collected from other group)

Observation No	Inlet Air					Outlet Air					Water		
	Dry Bulb Temp.	Wet Bulb Temp.	Relative Humidity	Enthalpy	Specific Humidity	Dry Bulb Temp.	Wet Bulb Temp.	Relative Humidity	Enthalpy	Specific Humidity	Inlet Temperature	Outlet Temp.	Water Flow Rate
	$^{\circ}\text{C}$	$^{\circ}\text{C}$	%	kJ/kg	kg/kg	$^{\circ}\text{C}$	$^{\circ}\text{C}$	%	kJ/kg	kg/kg	$^{\circ}\text{C}$	$^{\circ}\text{C}$	kg/s
1	26.2	19.8	55	56.32	0.0117	26.4	20.3	57	58.03	0.0123	43	38	0.43
2	26.1	19.6	54.5	55.64	0.0115	26.6	21	60.5	60.50	0.0132	42	37	0.40
3	26.2	20.0	56.5	57.00	0.0120	26.8	20.8	58	59.77	0.0128	38	36	0.36
4	25.3	19.8	60	56.37	0.0121	25.6	20.4	62	58.43	0.0128	36	34	0.33
5	25.8	20.8	64	59.83	0.0133	25.8	21.2	70	61.31	0.0141	35	34	0.30

A3:

Ambient Relative Humidity(%)	Month
55	April
72	May
79	June
79	July
79	August
78	September
78	October
78	November
77	December

A4:

Approach (°C)	Efficiency (%)	
	Natural	Induced
25	31.76	55.55
22	29.45	54.75
18	18.94	49.03
18	16.69	48.15
15	9.26	46.87

A5:

Entering WBT of Air (°C)	Water Outlet Temperature (°C)	
	Natural	Induced
18	36	33
19	35.5	32
20.5	35	31.8
22	34.5	30
21.5	34	29

A6:

Flow Rate (kg/s)	Efficiency (%)	
	Natural	Induced
.317	32	43
.35	29	39.75
.383	25	35
.417	20	33
.45	15	32

A7:

Water Inlet Temperature (°C)	Cooling Range	
	Natural	Induced
47	8	9
43	5	7
42	3.5	6
38	2	5
36	2	5
35	2	5

A8:

Water Inlet Temperature (°C)	Evaporation Loss	
	Natural	Induced
45	0.543	1.93
43	0.495	1.72
38	0.432	1.53
37	0.410	1.50
35	0.39	1.48

A9:

L/G	Efficiency (%)
0.49	26.32
0.45	28.54
0.42	29.19
0.35	39.02
0.32	55.55

A10:

Log (L/G)	Log(NTU)
-0.309	-0.844
-0.347	-0.895
-0.409	-0.801
-0.444	-0.725
-0.495	-0.672

A11:

NTU	Efficiency (%)
0.08589	29.19
0.15814	49.18
0.18844	54.54
0.21299	55.55

A12:

Flow Rate (Kg/s)	Efficiency (%)
0.467	28.5
0.43	28
0.367	30
0.34	33
0.33	39.15

A13:

Flow Rate (Kg/s)	Efficiency (%)		
	Water Inlet Temp. 48 °C	Water Inlet Temp. 43 °C	Water Inlet Temp. 38 °C
0.467	38.5	37.5	36
0.43	38	37	36.5
0.367	40	38	37
0.34	43	40	38
0.35	49.16	48	47.9

A14:

Dry Bulb Temperature (°C)	Month
26	April
28	May
29	June
29	July
28	August
25.5	September
24	October
18	November
14	December

A15:

RH (%)	Efficiency (%)
77	31.45
78	31
78	31
79	30.5
72	33.5
55	42.3
45	48

A16:

Flow Rate (kg/s)	Efficiency (%)	
	With Ink	Without Ink
0.45	28.5	42.55
0.417	28	45.11
0.383	30	51.43
0.35	33	55.17
0.317	39.15	55.82

A17:

Flow Rate (kg/s)	Evaporation Loss (kJ/kg)	
	Induced	
	With Ink	Without Ink
0.45	1.83	2.18
0.417	1.75	1.90
0.383	1.59	1.786
0.35	1.50	1.60
0.317	1.40	1.52

A18:

Water Inlet Temperature (°C)	Evaporation Loss (kJ/Kg)	
	With Ink	Without Ink
47	1.98	2.178
43	1.72	1.90
40	1.53	1.786
37	1.50	1.592
33	1.40	1.52

A 19:

Flow Rate (Kg/s)	Range (°C)	
	Without Ink	With Ink
0.317	9	14
0.35	6	11
0.383	5	9
0.417	5	8
0.45	5	8

A 20:

Flow Rate (kg/s)	Range Without Ink (°C)
0.317	9
0.35	6
0.383	5
0.417	5
0.45	5

A 21:

Flow Rate (kg/s)	Efficiency (%) natural	
	Without Ink	With Ink
0.45	15	39.72
0.417	20	41
0.383	25	46
0.35	29	47.62
0.317	32	48.54

A 22:

Flow Rate (kg/s)	Efficiency (%) Induced	
	Without Ink	With Ink
0.45	28.5	42.55
0.417	28	45.11
0.383	30	51.43
0.35	33	55.17
0.317	39.15	55.82

A 23:

Ratio	Efficiency (%)			
	For 0.34 kg/s	For 0.367 kg/s	For 0.4 kg/s	For 0.43 kg/s
0.00134	49.5	39.55	30.93	25.32
0.00174	59.17	43.71	40.46	29.13
0.00224	66.67	56.45	49.63	43.95
0.002633	64.51	60	56.45	48.78

A 24:

Ratio	Range	
	For 0.34 kg/s	For 0.43 kg/s
0.00134	8	6
0.001788	8	6
0.00224	8	6
0.00238	8	7

A 25: Data Table for Induced Draft with Ink (300ml/110L)

Observation No	Inlet Air					Outlet Air					Water		
	Dry Bulb Temp.	Wet Bulb Temp.	Relative Humidity	Enthalpy	Specific Humidity	Dry Bulb Temp.	Wet Bulb Temp.	Relative Humidity	Enthalpy	Specific Humidity	Inlet Temp.	Outlet Temp.	Water Flow Rate
	° C	° C	%	kJ/kg	kg/kg	° C	° C	%	kJ/kg	kg/kg	° C	° C	kg/s
1	27.7	21.5	58	62.42	0.0135	28.2	21.9	57.94	63.87	0.0139	49	40	0.467
2	27.6	21.2	56.85	61.34	0.0131	28	21.7	57.78	63.13	0.0137	44	36	0.433
3	27.6	21.5	58.64	62.41	0.0135	28.1	21.9	58.45	63.86	0.0139	40	33	0.400
4	28.1	22.7	67.30	66.90	0.0151	28.4	22.9	62.90	67.63	0.0153	38	32	0.367
5	27.7	21.8	60	63.51	0.0139	28.3	22.2	59	64.98	0.0943	37	31	0.330

A26: Data Table for Natural Draft with Ink (300ml/110L) (Collected from other group)

Observation No	Inlet Air					Outlet Air					Water		
	Dry Bulb Temp.	Wet Bulb Temp.	Relative Humidity	Enthalpy	Specific Humidity	Dry Bulb Temp.	Wet Bulb Temp.	Relative Humidity	Enthalpy	Specific Humidity	Inlet Temperature	Outlet Temperature	Water Flow Rate
	° C	° C	%	kJ/kg	kg/kg	° C	° C	%	kJ/kg	kg/kg	° C	° C	kg/s
1	27.6	21.7	60	60.15	0.0138	27.9	21.8	59	63.50	0.0138	49	44	0.467
2	28	21.6	57	62.77	0.0136	28.3	21.8	56.85	63.50	0.0137	44	39	0.433
3	27.9	21.5	57	62.4	0.0135	28.1	21.7	57.27	63.13	0.0137	40	36	0.400
4	27.6	20.5	65	66.13	0.0151	27.3	20.7	67.75	66.9	0.0155	38	34	0.367
5	27.5	21.7	60.4	63.16	0.0139	27.8	22	60.6	64.24	0.0143	37	34	0.333

A27: Data Table for Induced Draft with Ink (250ml/110L)

Observation No	Inlet Air					Outlet Air					Water		
	Dry Bulb Temp.	Wet Bulb Temp.	Relative Humidity	Enthalpy	Specific Humidity	Dry Bulb Temp.	Wet Bulb Temp.	Relative Humidity	Enthalpy	Specific Humidity	Inlet Temp.	Outlet Temp.	Water Flow Rate
	° C	° C	%	kJ/kg	kg/kg	° C	° C	%	kJ/kg	kg/kg	° C	° C	kg/s
1	28.2	22	59	64.24	0.0141	28.7	23	62	68	0.0153	50	40	0.466
2	27.8	22.1	61	64.63	0.0144	28.2	22.7	63	66.8	0.0151	46	38	0.433
3	26.9	22.8	71	67.32	0.0158	27.4	23.9	75	71.63	0.0173	43	35	0.4
4	27.6	23.6	70	70.42	0.0167	28.1	24.8	77	75.3	0.0184	40	33	0.367
5	26	22.5	65	70.45	0.017	26.5	23.8	71	71.21	0.0180	38	30	0.333

A 28: Data Table for Natural Draft with Ink (250ml/110L) (Collected from other group)

Observation No	Inlet Air					Outlet Air					Water		
	Dry Bulb Temp.	Wet Bulb Temp.	Relative Humidity	Enthalpy	Specific Humidity	Dry Bulb Temp.	Wet Bulb Temp.	Relative Humidity	Enthalpy	Specific Humidity	Inlet Temperature	Outlet Temperature	Water Flow Rate
	° C	° C	%	kJ/kg	kg/kg	° C	° C	%	kJ/kg	kg/kg	° C	° C	kg/s
1	28.4	22.3	59	65.36	0.0144	28.2	22.7	63	66.8	0.0151	50	45	0.466
2	27.9	21.9	59	63.89	0.014	28.3	22.3	61	65.37	.0146	46	41	0.433
3	28.1	22.4	61	65.55	0.0146	28.5	23.4	65	69.5	0.0159	43	38	0.40
4	27.8	24	73	72	0.0172	27.6	24.3	76	73.25	0.0178	40	35	.367
5	27.5	22.7	67	66.91	0.0154	27.8	24	73	72.02	0.0173	38	33	0.333

A 29: Data Table for Induced Draft with Ink (200ml/110L)

Observation No	Inlet Air					Outlet Air					Water		
	Dry Bulb Temp.	Wet Bulb Temp.	Relative Humidity	Enthalpy	Specific Humidity	Dry Bulb Temp.	Wet Bulb Temp.	Relative Humidity	Enthalpy	Specific Humidity	Inlet Temp.	Outlet Temp.	Water Flow Rate
	° C	° C	%	kJ/kg	kg/kg	° C	° C	%	kJ/kg	kg/kg	° C	° C	kg/s
1	25.6	23.5	84	70.11	0.0174	25.9	24.3	88	73.32	0.0186	54	48	0.467
2	25.3	23.4	85	69.73	0.0179	26	24.5	89	79.17	0.0188	49	43	0.433
3	25.7	23.6	84	70.5	0.0175	26	23.8	83	71.29	0.0177	43	36	0.4
4	25.7	23.4	83	69.71	0.0172	26	24.1	86	72.5	0.0182	44	36	0.366
5	25.3	23.3	84.65	69.31	0.0172	25.7	24	87	72.09	0.0181	43	35	0.333
				8					5	6			

A 30: Data Table for Natural Draft with Ink (200ml/110L) (Collected from other group)

Observation No	Inlet Air					Outlet Air					Water		
	Dry Bulb Temp.	Wet Bulb Temp.	Relative Humidity	Enthalpy	Specific Humidity	Dry Bulb Temp.	Wet Bulb Temp.	Relative Humidity	Enthalpy	Specific Humidity	Inlet Temperature	Outlet Temp.	Water Flow Rate
	° C	° C	%	kJ/kg	kg/kg	° C	° C	%	kJ/kg	kg/kg	° C	° C	kg/s
1	25.4	23.3	84	69.33	0.0172	26.3	24.5	86	74.13	0.0187	54	50	0.467
2	26.5	24.4	84	73.71	0.0185	26.8	25.1	87	76.63	0.0195	49	45	0.433
3	26	23.5	81	70.09	0.0172	26.1	23.7	82	70.88	0.0175	46	42	0.40
4	25.8	23.6	83	70.5	0.0175	26.7	25.2	89	77.06	0.0197	44	41	0.366
5	25	23	84.05	68.015	0.01689	25.8	23.9	85.54	71.68	0.0179	43	38	0.333

A 31: Data Table for Induced Draft with Ink (150ml/110L)

Observation No	Inlet Air					Outlet Air					Water		
	Dry Bulb Temp.	Wet Bulb Temp.	Relative Humidity	Enthalpy	Specific Humidity	Dry Bulb Temp.	Wet Bulb Temp.	Relative Humidity	Enthalpy	Specific Humidity	Inlet Temp.	Outlet Temp.	Water Flow Rate
	° C	° C	%	kJ/kg	kg/kg	° C	° C	%	kJ/kg	kg/kg	° C	° C	kg/s
1	25.6	23.2	82	68.93	0.0169	26.1	24.2	86	72.91	0.0183	50	43	0.467
2	25.4	24	89	72.12	0.0182	25.9	24.8	92	75.4	0.0194	46	40	0.43
3	25.6	23.5	85	70.51	0.0176	25.9	24.4	89	73.74	0.0187	45	39	0.40
4	25.3	23.6	87	70.52	0.0177	25.8	24.7	92	74.98	0.0192	43	36	0.367
5	25.5	23.6	85	70.51	0.0176	26.1	24.8	90	75.39	0.0193	40	32	0.34

A32: Data Table for Natural Draft with Ink (150ml/110L) (Collected from other group)

Observation No	Inlet Air					Outlet Air					Water		
	Dry Bulb Temp.	Wet Bulb Temp.	Relative Humidity	Enthalpy	Specific Humidity	Dry Bulb Temp.	Wet Bulb Temp.	Relative Humidity	Enthalpy	Specific Humidity	Inlet Temperature	Outlet Temperature	Water Flow Rate
	° C	° C	%	kJ/kg	kg/kg	° C	° C	%	kJ/kg	kg/kg	° C	° C	kg/s
1	25.6	23.7	85	70.91	0.0177	25.9	24	86	72.10	0.0181	50	47	.467
2	24.9	23.6	90	70.54	0.0179	25.2	24	91	72.13	0.0184	46	41	0.43
3	25.4	23.4	85	69.72	0.0173	25.6	23.9	87	71.71	0.0180	45	41	0.4
4	25.3	23.4	85	69.73	0.0174	25.6	23.6	86	71.31	0.0179	43	38	0.367
5	25.4	23.7	87	70.91	0.0178	25.7	23.9	89	73.33	0.0186	40	35	0.34

A33:

Flow Rate (kg/s)	Efficiency (%) (150 ml)	Efficiency (%) (250 ml)
0.467	28.69	45.87
0.43	29.13	43.95
0.4	30.93	49.63
0.367	39.55	56.45
0.34	55.17	66.67

A34:

NTU	Efficiency (%)
0.107	45.87
0.11735	43.95
0.16201	49.63
0.21889	56.45
0.34276	66.67

A35:

L/G	Efficiency(150ml)	Efficiency(200
0.4937	28.69	45.87
0.45	29.13	43.95
0.423	30.93	49.63
0.388	39.55	56.45
0.359	55.17	66.67

Appendix B:

B1: Calibration:

Flow Meter:

$$\text{Diameter of Drum, } d_{avg} = \frac{57+55.5}{2}$$
$$=56.25 \text{ cm}$$

For Time, $t = 305 \text{ sec}$

Height, $h = 5.6 \text{ cm}$

$$\text{Volume, } V = \frac{\tau}{4} d^2 h$$

$$\begin{aligned}
&= \frac{\tau}{4} \times (56.25)^2 \times 5.6 \\
&= 13916.30 \text{ cm}^3 \\
&= 13.91630 \times 10^{-3} \text{ m}^3 \\
&= 13.916 \text{ L}
\end{aligned}$$

$$\begin{aligned}
\text{Flow Rate theoretical, } \dot{V}_{wth} &= 13.916 \times 2 \\
&= 27.832 \text{ L/min} \\
&\approx 28 \text{ L/min}
\end{aligned}$$

& Flow Rate Shown by Gauge = 29 L/min

Second Time:

Initial Reading, $h_1 = 9.8 \text{ cm}$

Final Reading, $h_2 = 21 \text{ cm}$

Height, $h = h_1 - h_2$

$$= 21 - 9.8 \text{ cm}$$

$$= 11.2 \text{ cm}$$

Volume, $V = \frac{\tau}{4} d^2 h$

$$= \frac{\tau}{4} \times (56.25)^2 \times 11.2$$

$$= 27.8326 \text{ L}$$

For Time, $t = 60 \text{ sec}$

Volume Flow Rate, $\dot{V}_w = 27.8326 \text{ L}$

& Flow Rate Shown by Gauge = 29 L/min

B2: Calibration:

Item	Psychrometer Reading (° C)	Digital Reading ((° C)
Air inlet wet bulb temperature	23	23
Air inlet dry bulb temperature	26	26
Air outlet wet bulb temperature	41	41
Air outlet dry bulb temperature	42	42

B3:

// Example testing sketch for various DHT humidity/temperature sensors

// Written by ladyada, public domain

// DHT_dual_test

// Demonstrates multiple sensors

// Modified sketch by DIY-SciB.org

```

#include "DHT.h"

#define DHT1PIN 2 // what pin we're connected to
#define DHT2PIN 3

// Uncomment whatever type you're using!

#define DHT1TYPE DHT11 // DHT 11
#define DHT2TYPE DHT22 // DHT 22 (AM2302)
// #define DHTTYPE DHT21 // DHT 21 (AM2301)

// Connect pin 1 (on the left) of the sensor to +5V
// Connect pin 2 of the sensor to whatever your DHTPIN is
// Connect pin 4 (on the right) of the sensor to GROUND
// Connect a 10K resistor from pin 2 (data) to pin 1 (power) of the sensor

int val;

int tempPin = 1;

DHT dht1(DHT1PIN, DHT1TYPE);

DHT dht2(DHT2PIN, DHT2TYPE);

void setup() {

  Serial.begin(9600);

  Serial.println("DHTxx test!");

```



```

dht1.begin();

dht2.begin();

}

void loop() {

  // Reading temperature or humidity takes about 250 milliseconds!

  // Sensor readings may also be up to 2 seconds 'old' (its a very slow sensor)

  float h1 = dht1.readHumidity();

  float t1 = dht1.readTemperature();

  float h2 = dht2.readHumidity();

  float t2 = dht2.readTemperature();

  val = analogRead(tempPin);

  float mv = ( val/1024.0)*5000;

  float cel = mv/10;

  float farh = (cel*9)/5 + 32;

  // check if returns are valid, if they are NaN (not a number) then something went wrong!

  if (isnan(t1) || isnan(h1)) {

    Serial.println("Failed to read from DHT #1");

    delay(2000);

  } else {

    Serial.print("Humidity 1: ");

```

```

Serial.print(h1);

Serial.print(" %\t");

Serial.print("TEMPRATURE of LM35= ");

Serial.print(CEL);

Serial.print(" *C");

Serial.println();

    delay(2000);

Serial.print("Temperature 1: ");

Serial.print(t1);

Serial.println(" *C");

    delay(2000);
}

if (isnan(t2) || isnan(h2)) {

    Serial.println("Failed to read from DHT #2");

    delay(2000);

} else {

    Serial.print("Humidity 2: ");

    Serial.print(h2);

    Serial.print(" %\t");

    Serial.print("TEMPRATURE of LM35= ");

Serial.print(CEL);

Serial.print(" *C");

Serial.println();

```

```
    delay(2000);

    Serial.print("Temperature 2: ");

    Serial.print(t2);

    Serial.println(" *C");

    delay(2000);

}

Serial.println();

}
```

Appendix C:

C1:

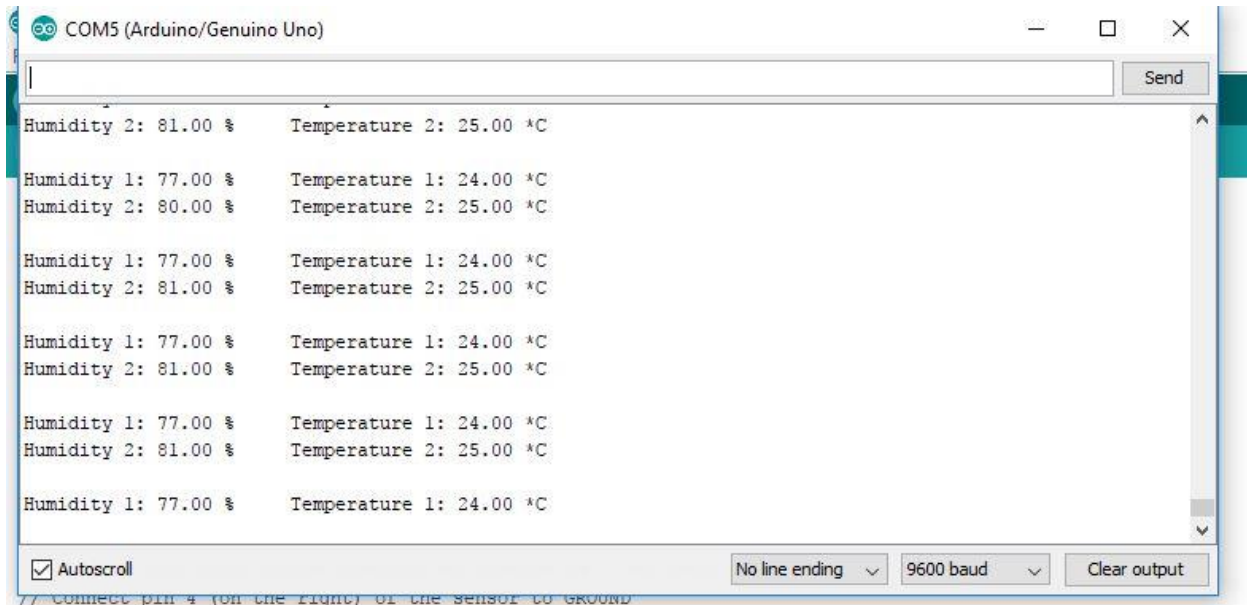

C2:

Humidity 2: 95.00 %	Temperature 2: 27.00 *C
Humidity 1: 92.00 %	Temperature 1: 25.00 *C
Humidity 2: 95.00 %	Temperature 2: 27.00 *C
Humidity 1: 89.00 %	Temperature 1: 25.00 *C
Humidity 2: 95.00 %	Temperature 2: 27.00 *C
Humidity 1: 88.00 %	Temperature 1: 25.00 *C
Humidity 2: 95.00 %	Temperature 2: 28.00 *C
Humidity 1: 89.00 %	Temperature 1: 25.00 *C
Humidity 2: 95.00 %	Temperature 2: 28.00 *C
Humidity 1: 88.00 %	Temperature 1: 25.00 *C
Humidity 2: 95.00 %	Temperature 2: 28.00 *C
Humidity 1: 86.00 %	Temperature 1: 25.00 *C
Humidity 2: 95.00 %	Temperature 2: 27.00 *C
Humidity 1: 86.00 %	Temperature 1: 25.00 *C
Humidity 2: 95.00 %	Temperature 2: 27.00 *C
Humidity 1: 86.00 %	Temperature 1: 25.00 *C
Humidity 2: 95.00 %	Temperature 2: 27.00 *C
Humidity 1: 88.00 %	Temperature 1: 25.00 *C
Humidity 2: 95.00 %	Temperature 2: 27.00 *C
Humidity 1: 89.00 %	Temperature 1: 25.00 *C
Humidity 2: 95.00 %	Temperature 2: 27.00 *C
Humidity 1: 90.00 %	Temperature 1: 25.00 *C
Humidity 2: 95.00 %	Temperature 2: 28.00 *C
Humidity 1: 88.00 %	Temperature 1: 25.00 *C
Humidity 2: 95.00 %	Temperature 2: 28.00 *C

Autoscroll